

Epson EH-TW9200W, EH-TW9200, EH-TW7200

PROJECTION LIKE YOU'VE NEVER SEEN BEFORE



EPSON[®]
EXCEED YOUR VISION

TRULY ADVANCED, GENUINELY INNOVATIVE PRODUCTS

Epson has been recognised as the global leader in the projector market for over a decade¹. Our latest range of high-end projectors use many of the world's most advanced technologies to ensure the products deliver a truly immersive home cinema experience.

SUPERB DYNAMIC CONTRAST

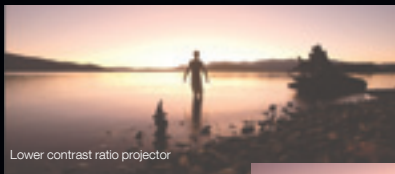

Lower contrast ratio projector

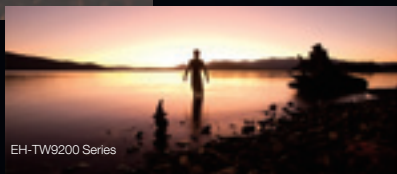

EH-TW9200 Series

Total clarity in all lighting conditions

Our high-end projectors offer higher levels of dynamic contrast than ever before - an unbelievable ratio of 600,000:1⁵. Paired with C2fine panels, our highly effective auto-iris feature ensures optimum blacks and more translucent whites in all scenes, bringing out the true brilliance of Full HD images.

SUPER-RESOLUTION

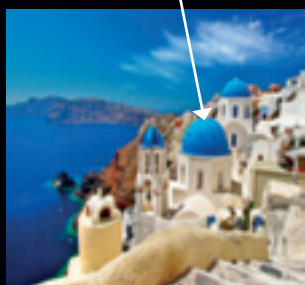

Without Super-Resolution



With Super-Resolution

Brings the best out of every film

Super-Resolution technology makes DVDs and standard definition content come alive via mixed colour separation techniques and imaging simulation. By independently sharpening each frame, it delivers crisp, clear images with super high-quality resolution.

2.1X OPTICAL ZOOM

100" screen	Projection distance (m)			Zoom Ratio
	Min	Max	Range	
EH-TW9200 Series	2.98	6.36	3.38	2.1

Flexible placement without loss of quality

Enjoy films at the highest quality in almost any size of room. With a lens system that provides an optical zoom ratio of 2.1x, the highest in their segment, our projectors offer extremely flexible placement options, without loss of image quality. This superb optical zoom capability also means that cables can be shorter, ensuring that any possible signal degradation is kept to an absolute minimum.

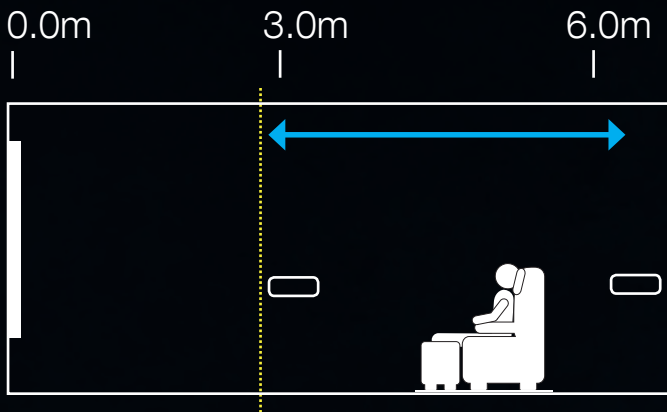

Lens shift

The optical lens shift function minimises image quality deterioration. You get a short focal length from as close as 298cm for a 100-inch screen with a broad vertical shift range of 96.3% and 47.1% horizontally.

CUTTING EDGE WIRELESS HD™2



Simple. Practical. Brilliant

Enjoy Full HD 2D and 3D viewing – without the hassle of connecting wires or cables. With Full HD technology for optimum quality at all times, our EH-TW9200W WirelessHD² projector offers HDCP-compliant transmission without buffering or drop out. You can even view a second device using the wireless picture-in-picture mode, and switch between up to five connected HDMI devices. The WirelessHD² transmitter also features a convenient MHL port for viewing smartphone and tablet content easily³.

RADIO FREQUENCY (RF) ACTIVE SHUTTER 3D GLASSES⁴



Outstanding 3D with active-shutter technology

Our Radio Frequency (RF) active shutter 3D glasses⁴ last up to 40 hours and quick-charge in just 3 minutes. You will experience immersive, high-quality 3D up to 10m away. They're perfect for any room, and with our unique luminance enhancement technology, you'll see bright 3D content without interference.

PICTURE-IN-PICTURE



Twice the entertainment on a single screen

Project two images (video or still) side-by-side from two different HDMI sources simultaneously⁶. Whether you want to browse pictures or play a game without missing a second of your favourite TV programme or film, our latest products offer a handy picture-in-picture feature to support your requirements.

THE BRIGHTEST COLOURS

Up to
3X BRIGHTER
COLOURS
with Epson Projectors⁷

High CLO means everything's bright

No one sells more projectors than Epson. Why? Brightness. We measure the Colour Light Output (CLO) instead of only measuring the white light. With Epson, images are consistently true-to-life and colours are up to three times brighter than 1-chip DLP home entertainment projectors⁷. You can be sure that our projectors will deliver truly bright, beautiful pictures every time.

FRAME INTERPOLATION

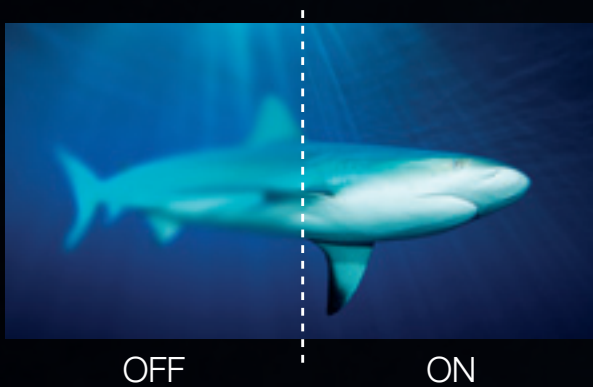

Eliminate flicker and judder

Even the fastest action sequences remain totally clear, thanks to Epson's unique Frame Interpolation technology⁵. By using this advanced process, intermediate frames are freshly generated, then inserted between original frames and driven at double speed. This virtually eliminates blurring, to give smoother and sharper motion sequences.

ULTRA BRIGHT 3D COLOURS

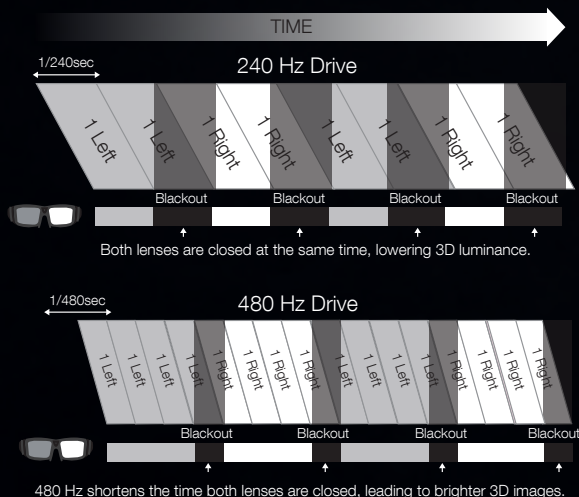

Outstanding image quality in 2D and 3D

Our bright 480 Hz drive technology is what makes this level of 3D brightness possible. This 480 Hz drive system minimises the blackout time of 3D glasses. The optimized 480 Hz optical engine makes 3D images up to 10% brighter than with our previous models.

THE BIG SCREEN EXPERIENCE - NOBODY DOES IT BETTER

As the world leader in imaging technology¹, we know a thing or two about how to deliver a high-quality on-screen 3D experience. So whether you're a film lover, or an avid sports fan, you'll love our latest range of high-definition home cinema projectors.

Offering exceptionally high contrast ratios and brightness, our projectors use some of the most advanced technologies in the world to further enhance image output. The result is that films are brighter and more alive and sports more compelling and involving. Whichever model you choose, you'll find it will transform your viewing experience by bringing the ultimate in immersive big screen cinematic entertainment into your home.



EH-TW9200W/EH-TW9200

THE ULTIMATE 3D HOME CINEMA EXPERIENCE FOR FILM FANATICS

With outstanding brightness and an unbelievably high contrast ratio of 600,000:1 in both 2D and 3D mode, these products offer a truly immersive cinematic experience. Fully ISF certified and featuring Epson's luminance enhancement technology for super 3D performance, they are easily adaptable to any home environment thanks to their range of flexible set up and connectivity options. And, for those who want all this without the hassle of wires, the EH-TW9200W offers wireless Full HD connectivity.

- 3D Full HD 1080p technology
- WirelessHD² (EH-TW9200W only)
- 600,000:1 contrast ratio
- High White and Colour Light Output of 2,400 lumens
- Frame interpolation in 2D and 3D modes
- Super-Resolution in 2D and 3D modes
- 2.1x optical zoom and wide lens shift capability
- ISF certified colour management
- MHL[®] (Mobile High-Definition Link) connectivity for viewing smartphone and tablet content³ (EH-TW9200W only)
- 2 pairs of Radio Frequency (RF) active shutter 3D glasses included⁴

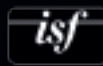



EH-TW7200

POWERFUL, YET AFFORDABLE, FULL HD 3D PROJECTIONS

Delivering superb high-quality images for a wide variety of content at an affordable price, this outstanding projector is extremely easy to set up and enables users to convert 2D high-definition films into 3D at the touch of a button.

With high levels of contrast ratio and brightness, it's a brilliant way to enhance your home cinema experience.

- 3D Full HD 1080p technology
- 120,000:1 contrast ratio
- High White and Colour Light Output of 2,000 lumens
- Super-Resolution in 2D and 3D modes
- 2.1x optical zoom and wide lens shift capability
- 1 pair of Radio Frequency (RF) active shutter 3D glasses included*



Full HD
1080p

3D

FULL HD
3D
GLASSES
RF

C²FINE™

3LCD

SPECIFICATIONS

Products	EH-TW9200W/EH-TW9200	EH-TW7200
Resolution/Aspect	Full HD 1080p, 1920×1080, 16:9	Full HD 1080p, 1920×1080, 16:9
LCD	0.74-inch wide panel with MLA	0.74-inch wide panel without MLA
Contrast ratio	600,000:1	120,000:1
White and Colour Light Output (lumens) (normal)	2,400lm	2,000lm
Screen size [Projected distance]	30" to 300" [0.87 to 9.03m] (Zoom: Wide) [1.88 to 19.15m] (Zoom: Tele)	30" to 300" [0.87 to 9.03m] (Zoom: Wide) [1.88 to 19.15m] (Zoom: Tele)
Throw ratio	1.34 (Zoom: Wide), 2.87 (Zoom: Tele)	1.34 (Zoom: Wide), 2.87 (Zoom: Tele)
Lamp life (hours) (standard/economy)	4,000/5,000	4,000/5,000
Lamp warranty	3 years/3,000 hours	3 years/3,000 hours
Optical zoom	2.1x	2.1x
Keystone correction (vertical)	±30°	±30°
Lens shift	V ±96.3% H ±47.1%	V ±96.3% H ±47.1%
Connectivity	2× HDMI, 1× Component, 1× RCA (Y), 1× D-sub 15pin, 1× RS-232C, 1× Trigger out, HDMI CEC, 1× USB Type B (service)	2× HDMI, 1× Component, 1× RCA (Y), 1× D-sub 15pin, 1× RS-232C, 1× Trigger out, HDMI CEC, 1× USB Type B (service)
Colour modes	Dynamic, Living room, Natural, Cinema, 3D Dynamic, 3D Cinema	Dynamic, Living room, Natural, Cinema, 3D Dynamic, 3D Cinema
Advanced features	Epson's bright 480 Hz drive technology, ISF certified, 2D to 3D conversion, MHL compatibility ³ (EH-TW9200W only), Frame Interpolation and Super-Resolution in 2D and 3D modes, DeepBlack technology, 3D depth adjustment, WirelessHD transmitter ² with 5 HDMI (EH-TW9200W only), Radio Frequency (RF) active shutter 3D glasses ⁴ ×2 included, Slide lens shutter (powered)	Epson's bright 480 Hz drive technology, 2D to 3D conversion, Super-Resolution in 2D and 3D modes, Radio Frequency (RF) active shutter 3D glasses ⁴ ×1 included, 3D depth adjustment, Slide lens shutter (powered)
Optional accessories	3D glasses ELPLGS03, USB Charging Adapter ELPAC01, Air filter ELPAF39, Spare lamp ELPLP69, Ceiling mount ELPMB30 / ELPMB22	3D glasses ELPLGS03, USB Charging Adapter ELPAC01, Air filter ELPAF39, Spare lamp ELPLP69, Ceiling mount ELPMB30 / ELPMB22
Weight (kg)	8.6/8.4	8.4
W x D x H (mm)	466 x 395 x 140	466 x 395 x 140

1 Survey conducted by Futuresource Consulting Limited for the period from 2001 to 2012.

2 WirelessHD function is available across the 27 members of the EU in addition to Croatia, Iceland, Norway, Saudi Arabia, Switzerland, Turkey and United Arab Emirates. Subject to change. Please contact your local Epson sales office for individual market availability.

3 To check the compatibility of your device, visit www.mhlconsortium.org. MHL, Mobile High-Definition Link and the MHL Logo are trademarks or registered trademarks of the MHL, LLC.

4 Epson Radio Frequency (RF) active shutter 3D glasses are part of the Full HD 3D Glasses Initiative, www.fullhd3dglASSES.com

5 EH-TW9200W/EH-TW9200 only.

6 Or via the WirelessHD transmitter - applicable to the EH-TW9200W only.

7 Compared to leading 1-chip DLP home entertainment projectors. Epson 720p projectors are three times brighter; Epson 1080p projectors are consistently two and up to three times

brighter. Based on NPD data, July 2011 through June 2012. Colour brightness (Colour Light Output) measured in accordance with IDMS 15.4. Colour brightness will vary depending on usage conditions.

For more information please visit www.epson.co.uk/CLO



Up to
3x
BRIGHTER
COLOURS
with Epson Projectors 7

No.1
SINCE 2001

EPSON
WORLD LEADER
IN PROJECTORS



3LCD

MHL

Full HD
1080p

Better Products for a Better Future

Warranty offers are not available for all countries. Please contact your local Epson representative.

For more information please contact:

Telephone: 01952 607111 (UK)
01 436 7742 (Republic of Ireland)
E-mail: enquiries@epson.co.uk
Chat: etalk.epson-europe.com
Fax: 0871 222 6740

Web: www.epson.co.uk
www.epson.ie

* Local call rate.

Trademarks and registered trademarks are the property of Seiko Epson Corporation or their respective owners. Product information is subject to change without prior notice.

EPSON®