

Versatile printing Consistent quality



Expand your offering and boost your bottom line

The SurePress L-4533 Inkjet Digital Label Press is designed and manufactured by Epson to deliver versatile printing, while maintaining consistent quality.

In addition to being easy to operate, the Surepress L-4533 offers consistent colour reproduction and precise colour matching. It allows label converters and commercial printers to meet the ever-changing creative needs of the customer, through high-quality and dependable performance on a wide range of substrates.

Exceptional quality in label printing

Variable sized droplet technology (VSDT) offers precise control for exceptional print definition and higher image quality.

Utilising smaller droplets and combining the edge smoothing function, gives you sharp text and crisp lines for barcodes and fine text. Printing with larger sized droplets provides solid vibrant colours, while minimising banding.

Easy-to-use spot colour refinement tools enable accurate colour matching and consistent output, time after time.

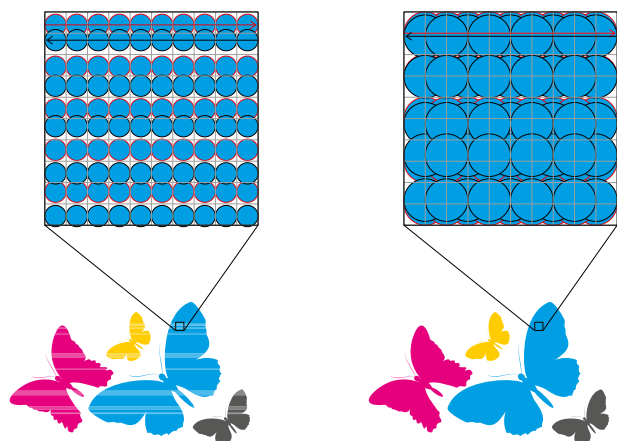

Solid colours print larger dots to minimise banding

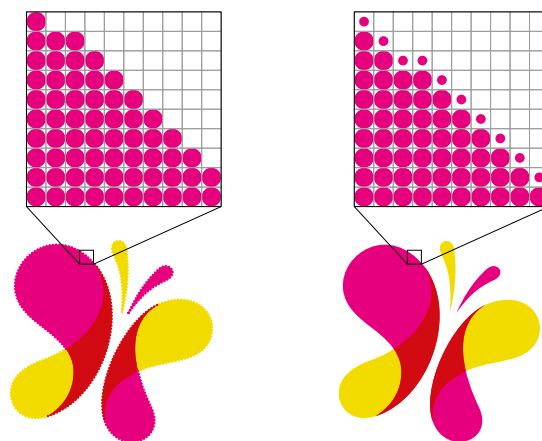

Use edge smoothing function for sharp text and crisp lines

Character edges are straight and sharp.

Rich colours with excellent image quality.

Reversed text is clearly legible.



High quality, accurate colour printing

Managing print quality consistently across a wide range of substrates is a challenge.

Epson produces and controls all technology inside the SurePress L-4533, from printheads to ink and software, and this is how we can achieve precise colour quality for every job on each substrate, every time.

Epson Micro Piezo multi-printhead array

Epson Micro Piezo printheads deliver perfectly accurate dot shapes and placement, providing sharp detail for barcodes and small text.



Epson Micro Piezo multi-printhead array

Variable sized droplet technology

Epson's Variable Sized Droplet Technology, with a minimum droplet of 3 picoliters, delivers smooth gradations and accurate colours for optimum image quality.

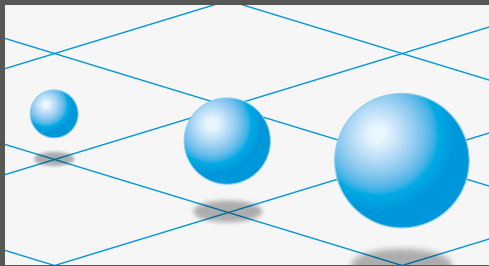

Variable sized droplet technology



Expanded colour gamut

Epson inks are renowned for their wide colour gamut and accurate colour reproduction. The green and orange inks in addition to cyan, magenta, yellow and black, expand the colour gamut for even higher accuracy and colour saturation. The difference is especially noticeable in the bright green to yellow and yellow-orange-red portions of the colour space. You will be able to match colours more accurately and the highly-saturated colours make labels look even more appealing.

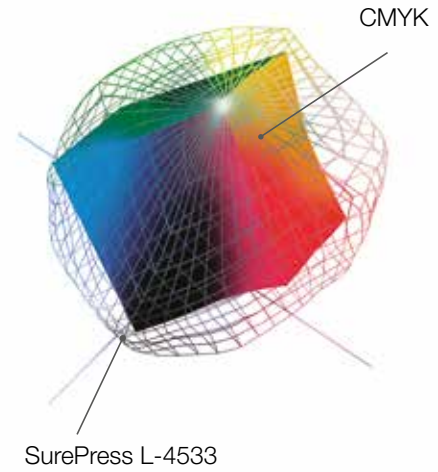

Epson SurePress AQ Ink

An opaque white ink is available on the AW version, which will expand your range of applications. The ink can be printed on top or underneath colours, providing even more variety to your labels.

Offering even more versatility, the SurePress L-4533 is equipped with two black inks for use with different substrates, ensuring rich, dense blacks. The 'standard' black is ideal for printing on coated papers and film substrates, and the 'uncoated' black ink has been specifically formulated for use on the uncoated papers generally used within the wine and beverage markets.



Six colours including green and orange for an extra-wide colour gamut

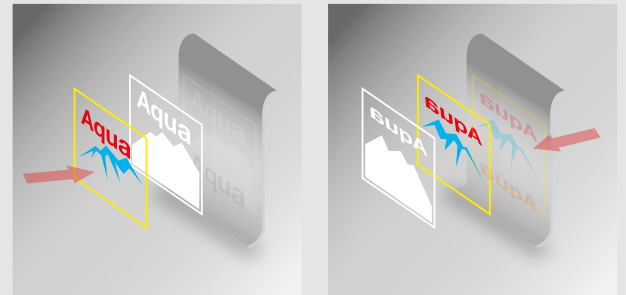

The L-4533 provides the flexibility of printing white first or last



Pantone® Certified¹

Wider Colour Gamut Epson SurePress L-4533 inks achieve up to 91% of PANTONE® Solid Coated Colours

Streamline your production

The SurePress L-4533 offers effortless printing with minimal maintenance for all label production.

The press is reliable, consistent and easy to use. A single operator can run multiple presses safely, enabling you to increase productivity. The press features auto head maintenance delivering a fast, efficient and reliable workflow. This allows you to print a higher number of short-run jobs, resulting in higher profitability.



Fast and efficient digital workflow

Conventional workflows involve additional time-consuming steps that are not necessary with the SurePress L-4533. A fast and efficient digital workflow reduces make ready and improves turnaround time for printing jobs.

Improved turn-around

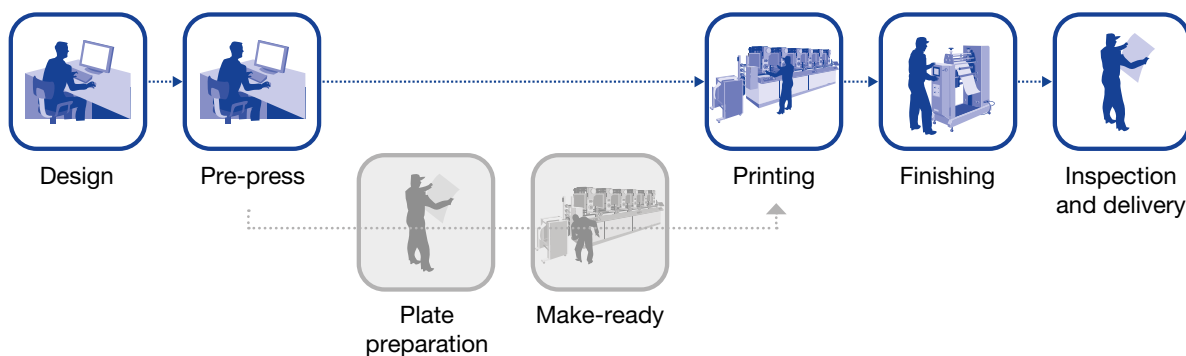

Conventional workflows require additional plate preparation and make-ready steps.

Variable data printing

The press offers full colour variable data workflow for text, barcodes and images. Utilising the Esko DFE to easily create and manage the variable data, you are able to pre-flight the information before sending the print job to press.

Sustainable printing

Personalisation with full colour variable data workflow for text, barcodes and images.

Utilising the Esko DFE to easily create and work with variable data printing jobs, you're able to pre-flight the information before sending to the press for printing.



User-friendly, touch screen operation

Designed for ease of use, the user-friendly touch screen provides full visibility of press operations. The operator can choose to receive job status updates by e-mail, a smart phone or tablet.

Minimise daily maintenance

With fast and easy set-up, the SurePress L-4533 is designed for maximum uptime and minimal operator intervention. Keep your print operations running smoothly with automated head maintenance and hot-swappable ink cartridges.

Epson Support

Epson provides full operator training on the press and Esko DFE. Our highly trained service engineers can use a remote monitoring system to review diagnostics and assist with supporting the press remotely.

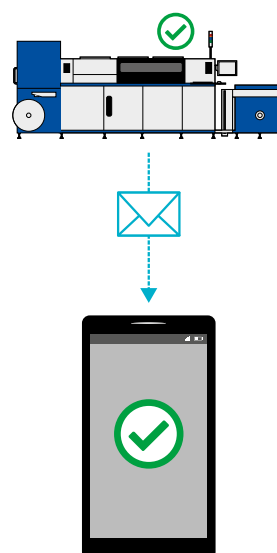

Model	SurePress L-4533A/L-4533AW
Print technology	Epson MicroPiezo inkjet technology
Resolution	Up to 720 x 1440dpi
Ink type	Water-based pigment ink (SurePress AQ Inks)
Ink cartridges	Black, Uncoated Black, Cyan, Magenta, Yellow, Orange, Green, Over print liquid, White ²
Web width	80mm to 334mm adjustable to support any width in this range
Image size	315.2mm x 914.4mm
Print speed	Up to 8.2 metres per min
Substrate support	Standard self-adhesive label substrates, semi gloss, gloss and matte paper, BOPP, PET and Yupo
Substrate thickness	80 to 320 microns
Unwinder capacity (max)	100kg weight/600mm diameter with 76mm inner core
Network connectivity	Ethernet 1000 Base-T or higher is recommended
Dimensions of press (WxDxH)	3788mm x 1847mm x 2016mm
Dimensions of Rewinder (WxDxH)	1310mm x 900mm x 1000mm
Power Requirements	Input voltage range: Rated voltage \pm 10% (180-220V). Rated voltage AC (3 phases 3 lines) 200V

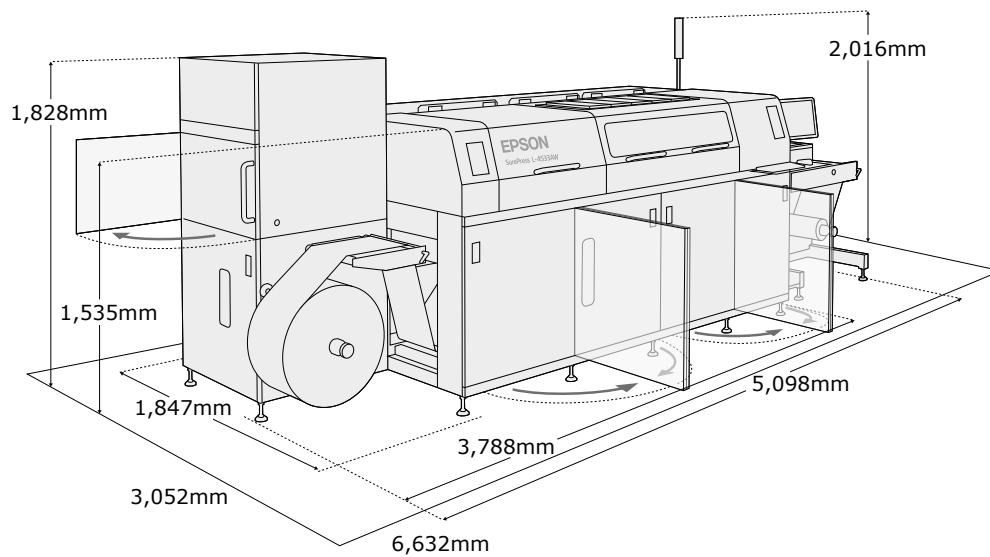

Committed to corporate and social responsibility

Epson is committed to developing environmentally conscious products, which means that sustainability is considered from conception to completion. We help customers recognise the environmental gains brought on by technology, whether it is redefining manufacturing through innovative robotics, saving energy with our office printing technology or revolutionising textile printing with digital solutions.

We are committed to all 17 United Nations' sustainable development goals and to the aims of the circular economy. We offer sustainable innovations because we recognise that the choices we make as organisations, individuals or a society will be essential to our shared success.

The content of this publication has not been approved by the United Nations and does not reflect the views of the United Nations or its officials or Member States www.un.org/sustainabledevelopment



1. The Pantone accreditation for SurePress L-4533 inks of 91% of PANTONE® Solid Coated Colors. Tested on Avery Primax 250TC/S692N/BG40W/BW6033B. Calculated using CIEDE2000 ≤ 1.5 tolerance. PANTONE® and other Pantone trademarks are trademarks or registered trademarks of Pantone LLC in the United States and/or other countries. PANTONE Trademarks used under License Agreement between Pantone LLC and Seiko Epson Corporation. All rights reserved.

2. White is available on the AW unit only

For further information please contact your local Epson office or visit www.epson-europe.com

Algeria (+2213) 770 938 617 Austria 01 253 49 78 333 Belgium +32 (0)2 792 04 47 Czech 800/142 052 Denmark 44 50 85 85 East Africa (+254) 734 354 075
 Finland 0201 552 091 France 09 74 75 04 04 (Cost of local call, operator charges may apply) Germany +49 (0) 2159/92 79 500 Greece (0030) 211 198 62 12
 Hungary 06800 147 83 Ireland 01 436 7742 Israel (+972)-3-5751833 Italy 02-660321 10 (0,12 €/min) Luxembourg +352 27860692 Middle East +9714 2677638
 Morocco (+212) 661 31 11 18 Netherlands +31 (0)20 708 5099 Norway +47 67 11 37 00 Poland 0-0-800 4911299 (0,16 zł/min) Portugal 707 222 111
 Romania 0040 214025024 Russia (095) 777-03-55 Slovakia 0850 111 429 Southern Africa (+2711) 465-9621 Spain 93 582 15 00 Sweden 0771-400135
 (Mobilsamtal – 0,99 kr/min, Lokala samtal – 0,30 kr/min, Utlandssamtal – 0,89 kr/min) Switzerland 022 592 7923 Tunisia (+216) 9833 3571 Turkey (0212) 3360303
 United Kingdom 0871 42 37766 (+10p per minute plus network extras) West Africa (+234)8020727843

Trademarks and registered trademarks are the property of Seiko Epson Corporation or their respective owners. Product information is subject to change without prior notice.