

# Versatile printing Consistent quality

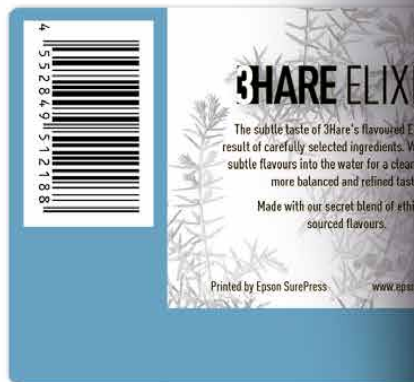
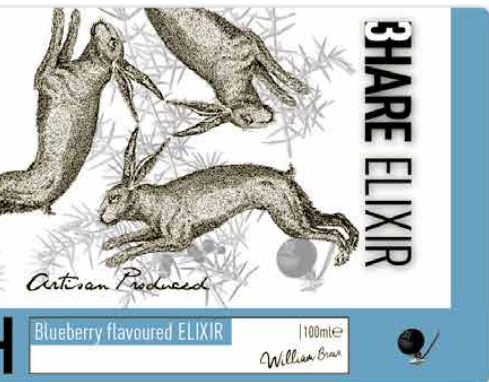

# Expand your offering and boost your bottom line

The SurePress L-4533 inkjet digital label press is designed and manufactured by Epson to deliver versatile printing, while maintaining consistent quality.

In addition to being easy to operate, the SurePress L-4533 offers consistent colour reproduction and precise colour matching. It allows label converters and commercial printers to meet the ever-changing creative needs of the customer, through high-quality and dependable performance on a wide range of substrates.

## Exceptional quality in label printing

Variable-sized droplet technology (VSDT) offers precise control for exceptional print definition and higher image quality.

Utilising smaller droplets and combining the edge-smoothing function, gives you sharp text and crisp lines for barcodes and fine text. Printing with larger sized droplets provides solid vibrant colours, while minimising banding.

Easy-to-use spot colour refinement tools enable accurate colour matching and consistent output, time after time.

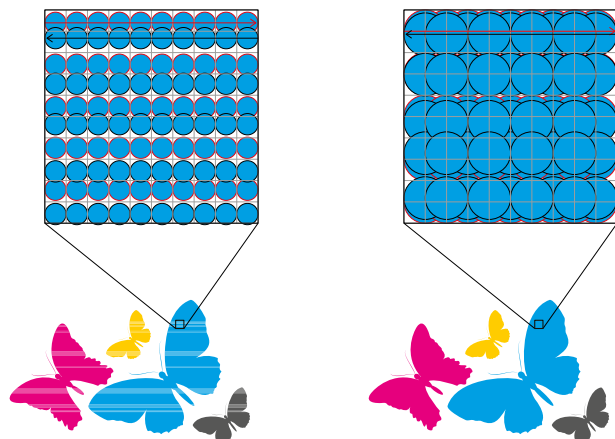

Solid colours print larger dots to minimise banding

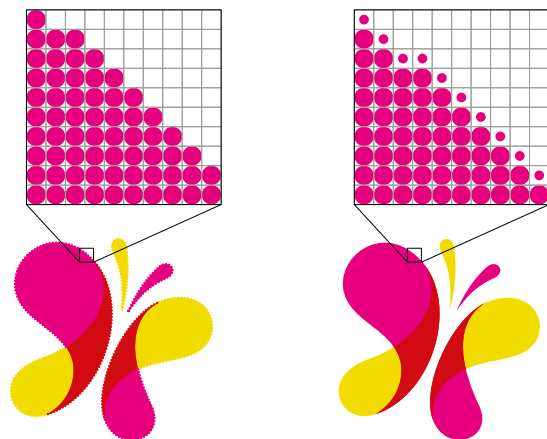

Use edge smoothing function for sharp text and crisp lines

Character edges are straight and sharp.

Rich colours with excellent image quality.

Reversed text is clearly legible.



# High quality, accurate colour printing

Managing print quality consistently across a wide range of substrates is a challenge.

Epson produces and controls all technology inside the SurePress L-4533, from printheads to ink and software, and this is how we can achieve precise colour quality for job, on each substrate, every time.

## Epson Micro Piezo multi-printhead array

Epson Micro Piezo printheads deliver perfectly accurate dot shapes and placement, providing sharp detail for barcodes and small text.



Epson Micro Piezo multi-printhead array

## Variable-sized droplet technology

Epson's variable-sized droplet technology, with a minimum droplet of three picoliters, delivers smooth gradations and accurate colours for optimum image quality.

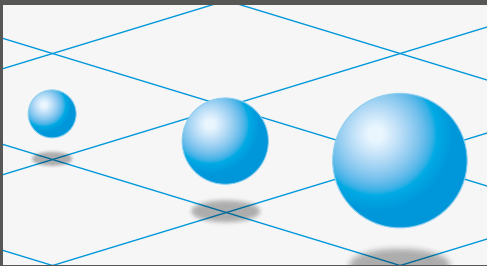

Variable-sized droplet technology



## Expanded colour gamut

Epson inks are renowned for their wide colour gamut and accurate colour reproduction. The green and orange inks in addition to cyan, magenta, yellow and black, expand the colour gamut for even higher accuracy and colour saturation. The difference is especially noticeable in the bright green to yellow and yellow-orange-red portions of the colour space. You will be able to match colours more accurately and the highly-saturated colours make labels look even more appealing.

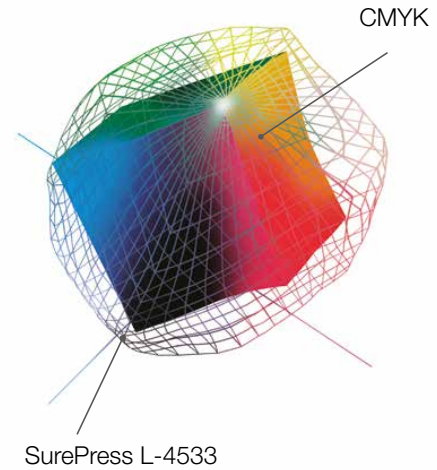

## Epson SurePress AQ Ink

An opaque white ink is available on the AW version, which will expand your range of applications. The ink can be printed on top or underneath colours, providing even more variety to your labels.

Offering even more versatility, the SurePress L-4533 is equipped with two black inks for use with different substrates, ensuring rich, dense blacks. The standard black is ideal for printing on coated papers and film substrates, and the uncoated black ink has been specifically formulated for use on the uncoated papers generally used within the wine and beverage markets.



Six colours including green and orange for an extra-wide colour gamut

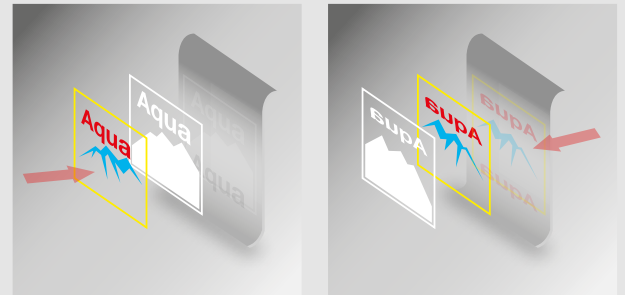

The L-4533 provides the flexibility of printing white first or last

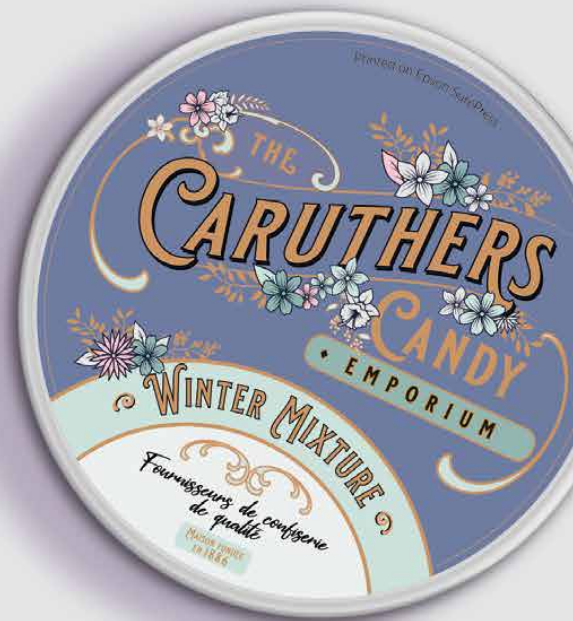

Pantone®-certified¹

Wider colour gamut Epson SurePress L-4533 inks achieve up to 91% of PANTONE® solid coated colours

# Streamline your production

The SurePress L-4533 offers effortless printing with minimal maintenance for all label production.

The press is reliable, consistent and easy to use. A single operator can run multiple presses safely, enabling you to increase productivity. The press features auto head maintenance delivering a fast, efficient and reliable workflow. This allows you to print a higher number of short-run jobs, resulting in higher profitability.



## Fast and efficient digital workflow

Conventional workflows involve additional time-consuming steps that are not necessary with the SurePress L-4533. A fast and efficient digital workflow reduces makeready and improves turnaround time for printing jobs.

## Improved turn-around

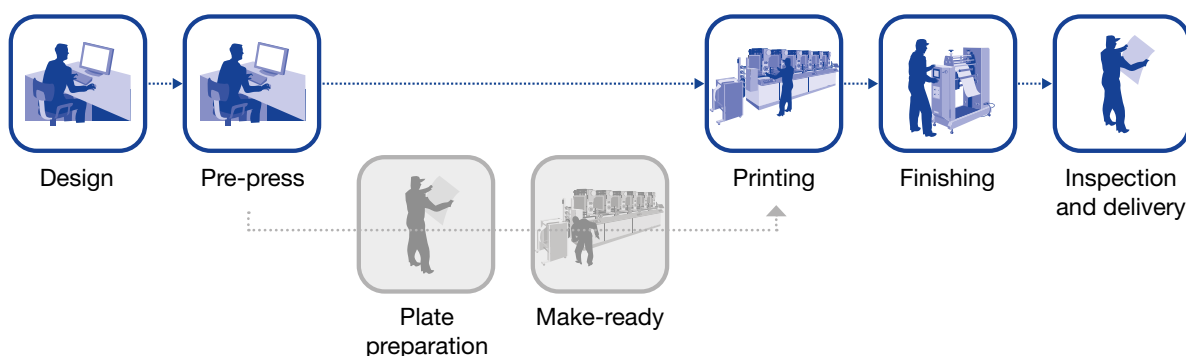

Conventional workflows require additional plate preparation and makeready steps.

## Variable data printing

The press offers full colour variable data workflow for text, barcodes and images. Utilising the Esko Digital Front End (DFE) to easily create and manage the variable data, you are able to pre-flight the information before sending the print job to press.

## Sustainable printing

Personalisation with full colour variable data workflow for text, barcodes and images.



### User-friendly, touch screen operation

Designed for ease of use, the user-friendly touch screen provides full visibility of press operations. The operator can choose to receive job status updates by email, a smart phone or tablet.

### Minimise daily maintenance

With fast and easy set-up, the SurePress L-4533 is designed for maximum uptime and minimal operator intervention. Keep your print operations running smoothly with automated head maintenance and hot-swappable ink cartridges.

### Epson Support

Epson provides full operator training on the press and Esko DFE. Our highly trained service engineers can use a remote monitoring system to review diagnostics and assist with supporting the press remotely.

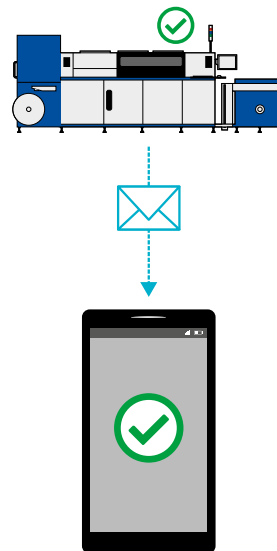

<b>Model</b>	<b>SurePress L-4533A/L-4533AW</b>
<b>Print technology</b>	Epson Micro Piezo inkjet technology
<b>Resolution</b>	Up to 720 x 1440dpi
<b>Ink type</b>	Water-based pigment ink (SurePress AQ Inks)
<b>Ink cartridges</b>	Black, Uncoated Black, Cyan, Magenta, Yellow, Orange, Green, Over print liquid, White <sup>2</sup>
<b>Web width</b>	80mm to 334mm adjustable to support any width in this range
<b>Image size</b>	315.2mm x 914.4mm
<b>Print speed</b>	Up to 8.2 metres per min
<b>Substrate support</b>	Standard self-adhesive label substrates, semi gloss, gloss and matte paper, BOPP, PET and Yupo
<b>Substrate thickness</b>	80 to 320 microns
<b>Unwinder capacity (max)</b>	100kg weight/600mm diameter with 76mm inner core
<b>Network connectivity</b>	Ethernet 1000 Base-T or higher is recommended
<b>Dimensions of press (WxDxH)</b>	3788mm x 1847mm x 2016mm
<b>Dimensions of Rewinder (WxDxH)</b>	1310mm x 900mm x 1000mm
<b>Power Requirements</b>	Input voltage range: Rated voltage $\pm$ 10% (180-220V). Rated voltage AC (3 phases 3 lines) 200V

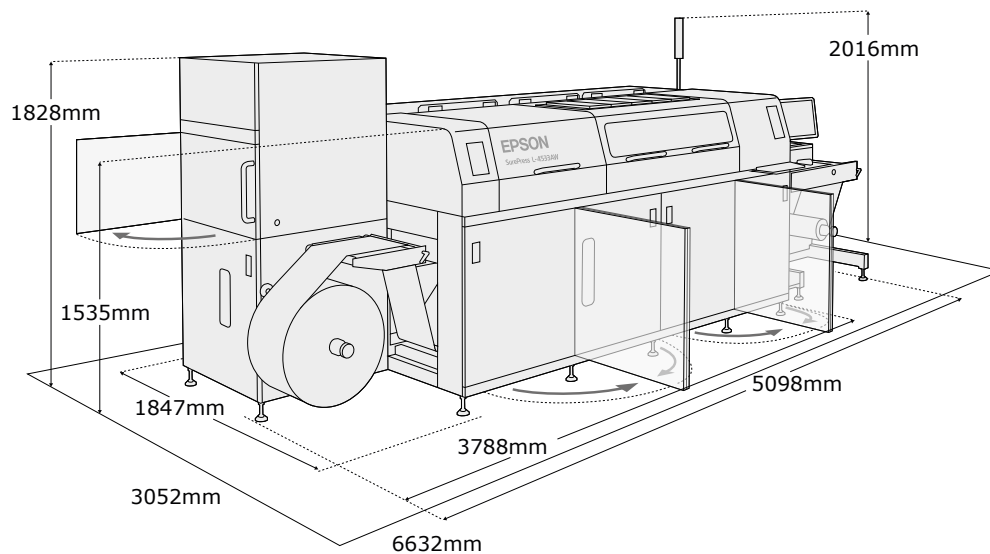

## Committed to corporate and social responsibility

Epson is committed to developing environmentally conscious products, which means that sustainability is considered from conception to completion. We help customers recognise the environmental gains brought on by technology, whether it is redefining manufacturing through innovative robotics, saving energy with our office printing technology or revolutionising textile printing with digital solutions.

We are committed to all 17 United Nations' sustainable development goals and to the aims of the circular economy. We offer sustainable innovations because we recognise that the choices we make as organisations, individuals or a society will be essential to our shared success.

The content of this publication has not been approved by the United Nations and does not reflect the views of the United Nations or its officials or Member States [www.un.org/sustainabledevelopment](http://www.un.org/sustainabledevelopment)



1. The Pantone accreditation for SurePress L-4533 inks of 91% of PANTONE® Solid Coated Colors. Tested on Avery Primax 250TC/S692N/BG40W/BW6033B. Calculated using CIEDE2000  $\leq$  1.5 tolerance. PANTONE® and other Pantone trademarks are trademarks or registered trademarks of Pantone LLC in the United States and/or other countries. PANTONE Trademarks used under License Agreement between Pantone LLC and Seiko Epson Corporation. All rights reserved.

2. White is available on the AW unit only

For more information please contact:

Home users: 0343 90 37766  
Business users\*: 0871 42 37766  
Republic of Ireland: 01 436 7742

Or visit us at [www.epson.co.uk/contactus](http://www.epson.co.uk/contactus)

\* 10p per minute plus network extras.

Trademarks and registered trademarks are the property of Seiko Epson Corporation or their respective owners. Product information is subject to change without prior notice.

