

EB-L20000U/EB-L12000Q

A universe of possibilities



EPSON[®]
EXCEED YOUR VISION

Create stunning displays and immersive environments

Reach spectacular levels of performance, reliability and easy operation with our new EB-L20000U/EB-L12000Q display solutions. Compact but powerful, with resolution up to native 4K and versatile features, they lead the way in high-lumen visual communication for demanding installation environments.

Powerful and compact

3LCD technology with laser light source
20,000lm and WUXGA resolution
(EB-L20000U)
12,000lm and Native 4K resolution
(EB-L12000Q)
Light and compact (620x280x720 mm)
50kg (EB-L20000U), 51kg (EB-L12000Q)

Reliable

20,000-hours¹/5 years maintenance-free
with warranty
Triple-layer dust-proof structure with sealed
engine
Lightweight but very robust body
Comprehensive local and online monitoring

Flexible

Zero offset, ultra short-throw lens
Wide-range of optical lenses
Auto geometry correction
Epson Professional Tools software
Exceptional connectivity
Single or multi-projector solutions



²EB-L12000Q



EB-L20000U

20,000lm
WUXGA
50kg



EB-L12000Q

12,000lm
Native 4K panel
51kg



Powerful and compact

EB-L20000U/EB-L12000Q is an incredibly bright, light and compact display solution that brings breathtaking images to high-powered environments. From large scale presenting to breathtaking exhibitions, it is easy to install and gives audiences a truly stunning performance every time.

Smaller size, cooler operation

A newly developed liquid cooling system helps to achieve a smaller body size, and no matter how the projector is installed it keeps things cooler, from the inorganic LCD panels and inorganic phosphor wheel to the laser light source.

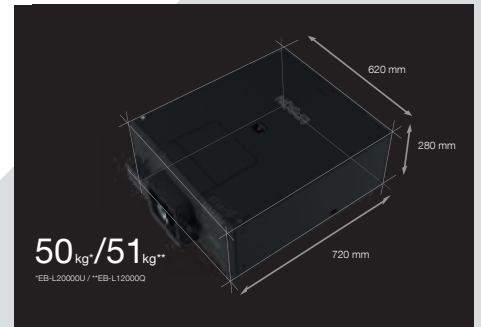
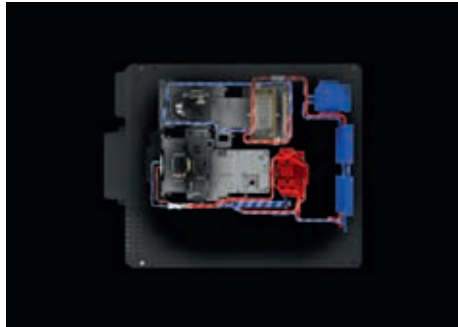

Native 4K panel[†]

Our 1.03-inch, native 4K panel delivers ultra-high definition image quality that takes our display solutions into a new world of image clarity and audience engagement.



3LCD panel

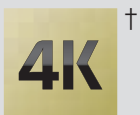

* EB-L20000U † EB-L12000Q

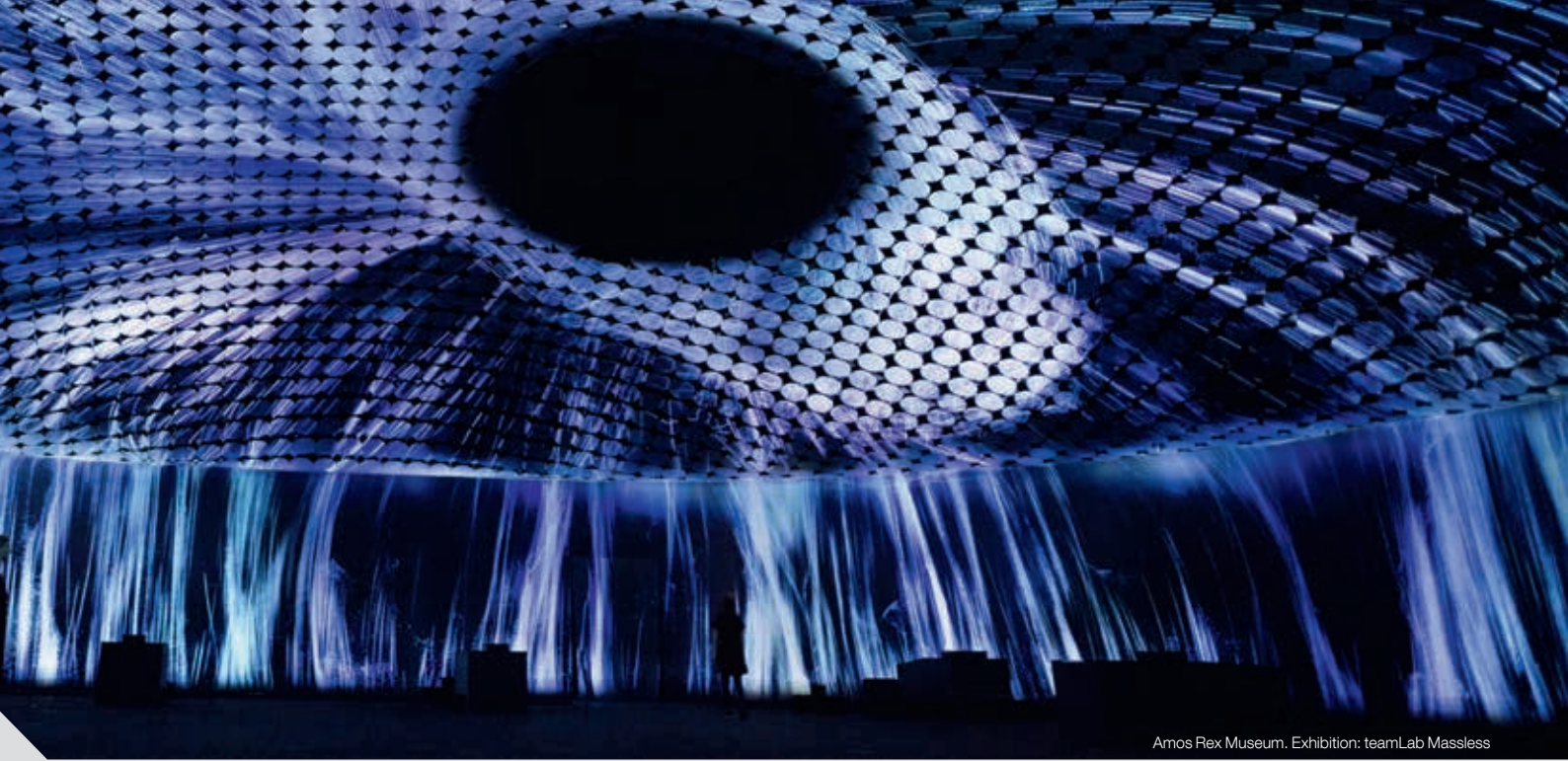

Amos Rex Museum. Exhibition: teamLab Massless

Frame interpolation⁴

Deliver smoother video and reduce after-images even for sports and other fast moving content with frame interpolation. This carries out frame-by-frame analysis and then generates intermediate frames for a 100Hz/120Hz frame rate.

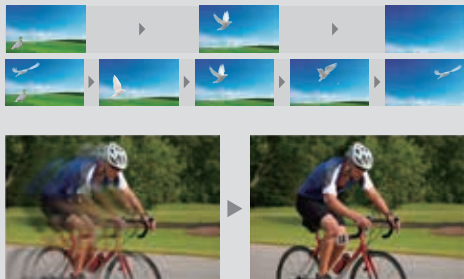

High dynamic range

Achieve a minimum of white or black spotting and dynamic output over a broad tonal range with support for HDR10 and Hybrid long-gamma.

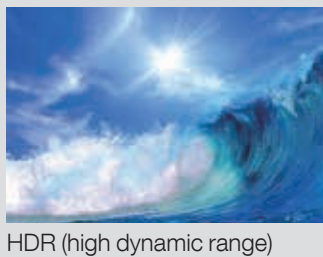
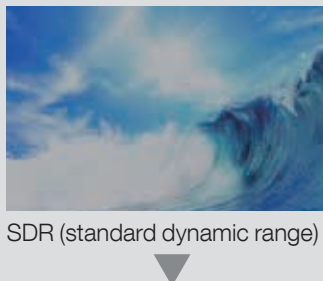

Image enhancement

Maintain crisp and extremely detailed edges with Epson's unique high-quality image signal processing.



Without image enhancement technology



With image enhancement technology

Light-out control

Control the laser light source by turning it on or off depending on the black level value of the video signal.

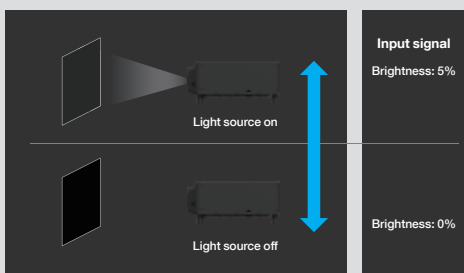

* Simulated images

Reliable

Enjoy 20,000 hours of maintenance-free use¹, backed up by a warranty², thanks to the newly designed laser light source and advanced electrostatic filters of the EB-L20000U/EB-L12000Q. Its inorganic LCD panels, inorganic phosphor wheel and triple-layer dustproof structure enable maximum reliability during use.

Triple-layer dustproof structure

Three layers of protection deliver excellent durability and dust-resistance. The light source and key optical components are sealed, while the liquid cooling system, independent airflow and long-life filters help these presenting solutions achieve new levels of reliability.

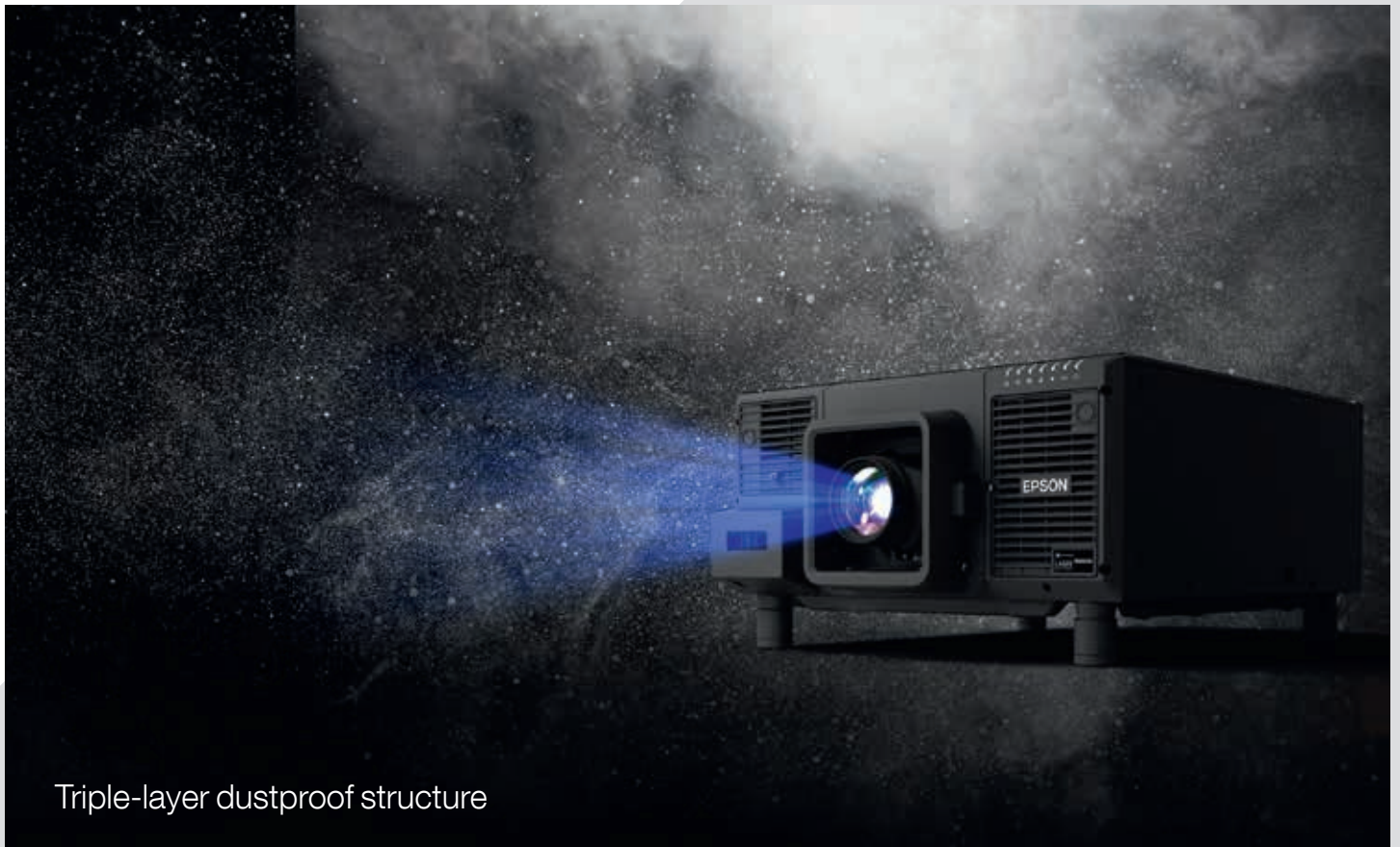
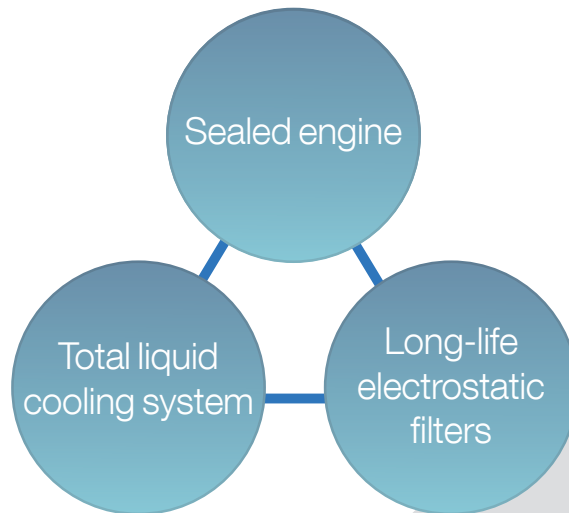



Sealed optical engine

To ensure perfect images even in more demanding environments, the key components are sealed and therefore impermeable to smoke, dust and other outside elements that can compromise performance.

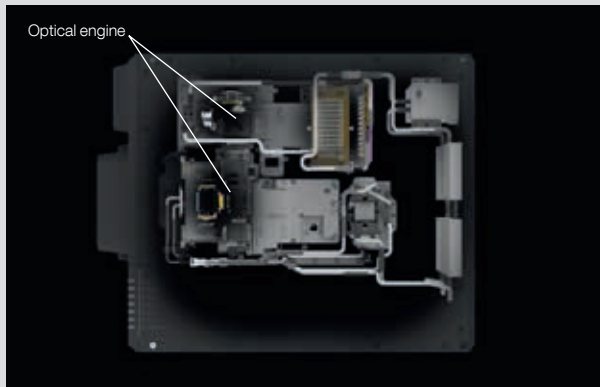

Airflow reduced by 86%⁵

The new total liquid cooling system takes in air independently for both the radiator and power supply. This further assists with dust proofing and durability by reducing airflow to the optical engine by 86% compared to conventional models⁶.

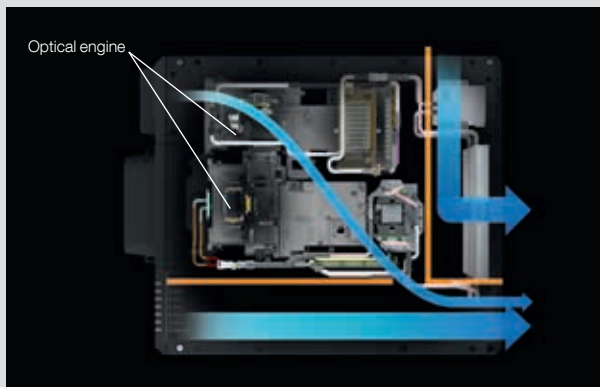

Long-life, replaceable electrostatic filters

Vastly reduce incoming dust levels with electrostatic filters that capture microscopic particles and are extremely long lasting, giving you 20,000 hours¹ of highly effective, maintenance-free use. They are also very easy to replace.

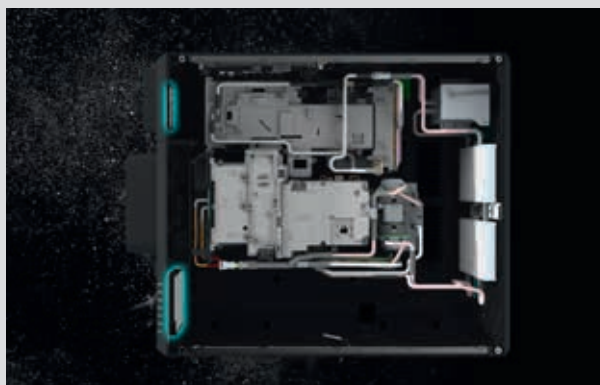

Maintenance-free light source

Laser light source can operate for up to 20,000 hours maintenance free⁷. The laser light source is highly reliable, eliminating the worry of the light burning out during important presentations.

Robust body

A pipe frame and base-plate structure greatly improves the durability of the casing. The internal structure has been redesigned to achieve a compact, lightweight design that makes installation easy.

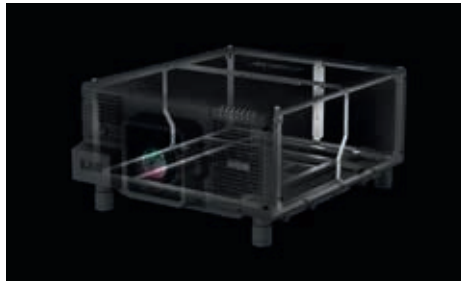

Inorganic LCD panels

LD (laser diode) package

Inorganic phosphor wheel

Electrostatic filters

LD package

Inorganic phosphor wheel

Electrostatic filter

Inorganic LCD panels (Red/Green/Blue)

Electrostatic filter

3LCD

LASER
LIGHT SOURCE

The diagram shows the internal optical path of the projector. A laser diode package (LD package) emits light that passes through an inorganic phosphor wheel. The light then passes through an electrostatic filter and is directed to three inorganic LCD panels (Red/Green/Blue). The light from these panels is then filtered by another electrostatic filter before exiting the projector. The main diagram is surrounded by inset images showing individual components: Inorganic LCD panels, LD (laser diode) package, Inorganic phosphor wheel, and Electrostatic filters.



Status monitor

Quickly check the signal, voltage and network information via the monitor.



Power supply log

Monitor and log times with drops in voltage. The ability to log up to 30 voltage drops can help determine the cause of unexpected shutdowns.

Mechanical shutter

This internal shutter protects from laser lights that are sometimes included in lightshows.

Settings on standby

Configure IP settings and reset default values without powering up.

Constant brightness

Maintaining a specific brightness over a prolonged period of time, depending on the application, offers increased flexibility. Venues such as an art museum can take advantage of this feature in situations where constant brightness is a must.

Custom brightness

Add precision by adjusting brightness in increments of 1%. This makes it easy to perfectly match brightness levels to your viewing environment and can prolong projector life.

* Approximate time until brightness decreases 50% from first usage. Time varies depending on usage conditions and environments.

Custom mode with constant brightness

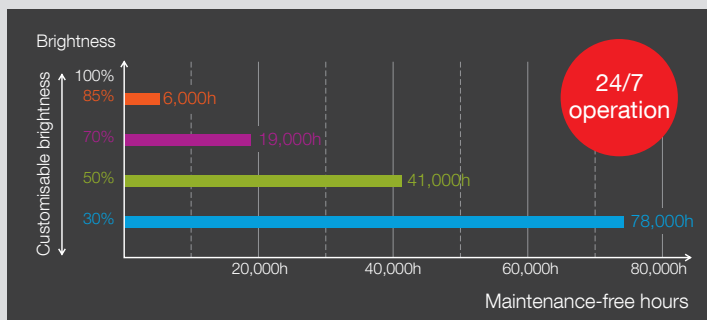

Custom brightness

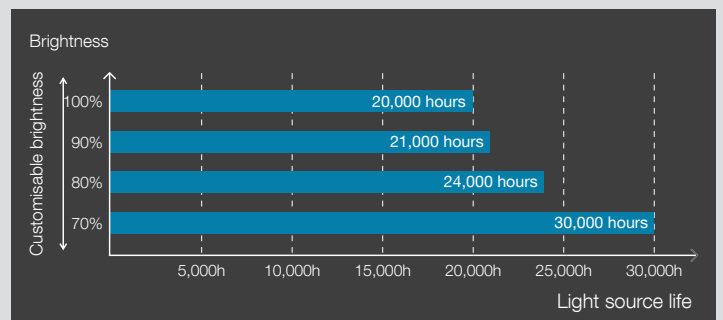

Flexible

The EB-L20000U/EB-L12000Q offers maximum flexibility in a range of display environments. These include a wide range of lenses to suit any setting or angle, comprehensive set-up and management tools, advanced imaging techniques and future-proof interfaces.

Zero offset, ultra short-throw lens

Create breathtaking images on 100-inch screens from only 41cm away with this 0.35 ultra short throw ratio lens and zero-offset, bending optical system. Expand the visual potential of locations where lens-to-screen distances are extremely limited.

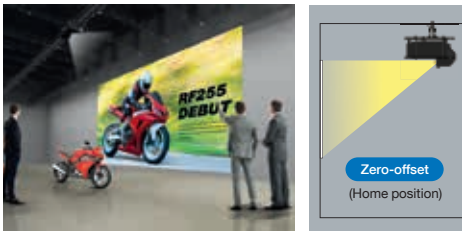

Larger image from shorter distances, plus added installation flexibility

Wider lens shift range

Simplify operation and expand usability with extremely wide-ranging lens shift[§] and more precise adjustment via an improved stepping motor for the range shift mechanism.

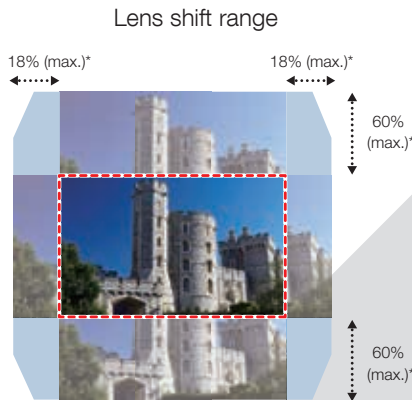

* When using the ELPLM15 lens
 § 58% (max.) vertically; 15% (max.) horizontally for EB-L12000Q

Powered lens position memory

To save time and simplify set-up, as many as 10 settings can be stored in the projector memory, including shift positions, focus adjustments and projection sizes.

Expansion slots

Expand custom hardware compatibility and future-proof your display solution with versatile interface slots.

- ELPIF01: HDMI/DVI
- ELPIF02: SDI*
- ELPIF03: Display port
- * Only for EB-L12000Q



Wide range of optical lenses

Match your specialist requirements and add flexibility to installation with a range of interchangeable lenses. These can also help to keep costs low because EBL-20000U/EBL-12000Q is compatible with lenses that fit the current Epson L1700 series (including 4k-compatible lenses).

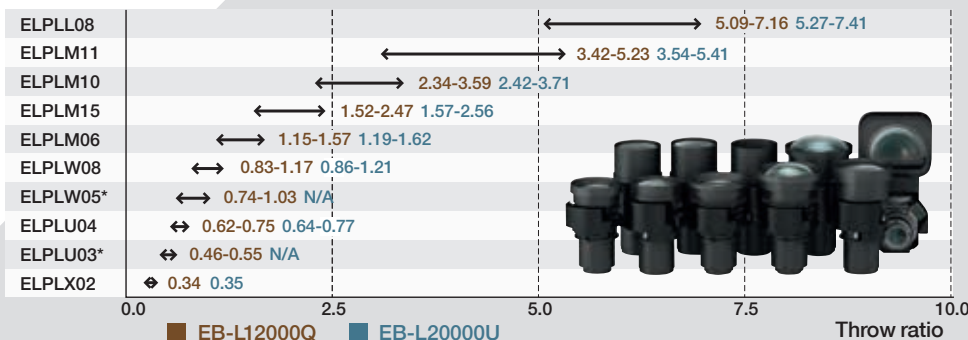

* Only for EB-L12000Q



Epson Projector Professional Tool

Simplify setup of multi-projector installations with this tool that offers intuitive correction for geometry such as edge-blending and curved surfaces, as well as colour matching and brightness.

Multiple interfaces

Ensure firm connections and long-lasting performance throughout regular use with the robust, lockable etherCON LAN terminal. Project 4K images using one cable and output a 12G signal from the output terminal with 12G SDI[®] support³. Support for 4K 120 Hz signals is provided by the optional ELPIF03 interface board with DisplayPort connector.

Tiling assist

Create seamless multi-projector displays with the help of the built-in camera. This automatically compensates for overlapping areas and corner positions to ensure perfect big screen images.

Multi-directional projection

Add versatility by rotating your display solution 360° in any direction - horizontally, vertically and rotationally.

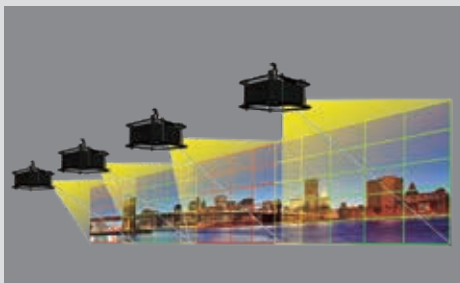
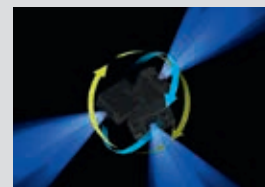
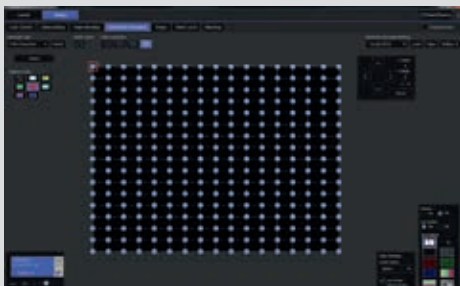

Information and control

Remotely monitor and control up to 2,000 networked projectors with easy to use Epson Projector Management. Keep informed of projector status, power settings and any other issues via icons or email notifications.

Auto-colour adjustment

The built-in camera detects subtle colour inconsistencies between multiple projectors. It can identify screens that have become unevenly coloured over time, allowing the projector to automatically make colour corrections. This function can be set to check colour manually or automatically at regular intervals to deliver stable image quality with minimal maintenance.

Web control with multi-device support

Use a computer web browser or smart devices to adjust display settings. The new OSD Control Pad function allows control of the menu and will even show a graphic of the lens-condition on a smart device.

EB-L20000U/EB-L12000Q has support for DMXArtNet to enable lighting effects such as pre-programmed sequences to be synchronized with audio content.

Up to
3X BRIGHTER
COLOURS
with Epson Projectors²

No.1
SINCE 2001
EPSON
WORLD LEADER
IN PROJECTORS¹



Better Products for a Better Future™

¹ Approximate time until brightness decreases 50% from first usage. Measured by acceleration test assuming use of 0.04 - 0.20 mg/m³ of particulate matter. Time varies depending on usage conditions and environments.

² Five years or 20,000 hours, whichever comes first.

³ EB-L12000Q only.

⁴ EB-L20000U only.

⁵ Measured by acceleration test assuming use of 0.04 - 0.20 mg/m³ of particulate matter. Time varies depending on usage conditions and environments.

⁶ Compared with EB-L25000U. Results may vary depending on usage conditions.

⁷ No maintenance for the laser light source required up to 20,000 hours. Approximate time until brightness decreases 50% from first usage. Measured by acceleration test assuming use of 0.04 - 0.20 mg/m³ of particulate matter. Time varies depending on usage conditions and environments. Replacement of parts other than the light source may be required in a shorter period.

⁸ EB-L20000U -5%/+20% vertical, ±15% horizontal. EB-L12000Q -5%/+8% vertical, ±5% horizontal.

⁹ Only SDI terminal 1

For further information please contact your local Epson office or visit www.epson-europe.com

Epson Middle East

P.O. Box 371567, Dubai

United Arab Emirates

Telephone: +9714 2677638

www.epson-middleeast.com

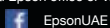

Trademarks and registered trademarks are the property of Seiko Epson Corporation or their respective owners. Product information is subject to change without prior notice.

EPSON®