

# One controller for all



# Adaptable intelligence

Compact, powerful and flexible enough to meet your demands, the new Epson RC700-A controller is a true all-rounder. It works either as a stand-alone or integrated system. If it's extended to create a multi-manipulator controller, the Epson RC700-A can control several robots and peripheral devices in a complex system.

**Tomorrow's automation begins with Epson.**



Featuring Epson QMEMS® technology, the Epson RC700-A is designed for the next generation of robots. Thanks to QMEMS, vibrations are considerably reduced, even when decelerating, or at high starting speeds. This improves production throughput and ensures a consistently high quality of assembly work, even at high speeds.

## Table of contents

Integrated concept, networking	04 / 05
Expansion cards, conveyor tracking	06 / 07
Technical Data for Epson RC700-A controller	08 / 09
Epson RC+ 7.0 development interface and software options	10 / 11
Epson SPEL+ programming language	12
Software tools	13
Epson Simulator	14
About Epson	15
Service & Support	16

## Features and benefits

Powerful universal controller can be expanded into a multi-manipulator controller

Multitasking

Compact design

Low power consumption

Low power loss

Graded safety systems (safety door circuits/emergency stop circuits)

Remote control and maintenance possible with additional PC

Industry standard inputs/outputs

One/two-phase connectivity

TCP-IP connection

RS-232 connection

Real-time inputs/outputs

Integrated motor circuit breaker

Status indicator

The Epson RC700-A can be used with SCARA robots from the G and RS series, and the 6-axis robots from the C4, C8 and N2 series, as well as with future generations of robots.

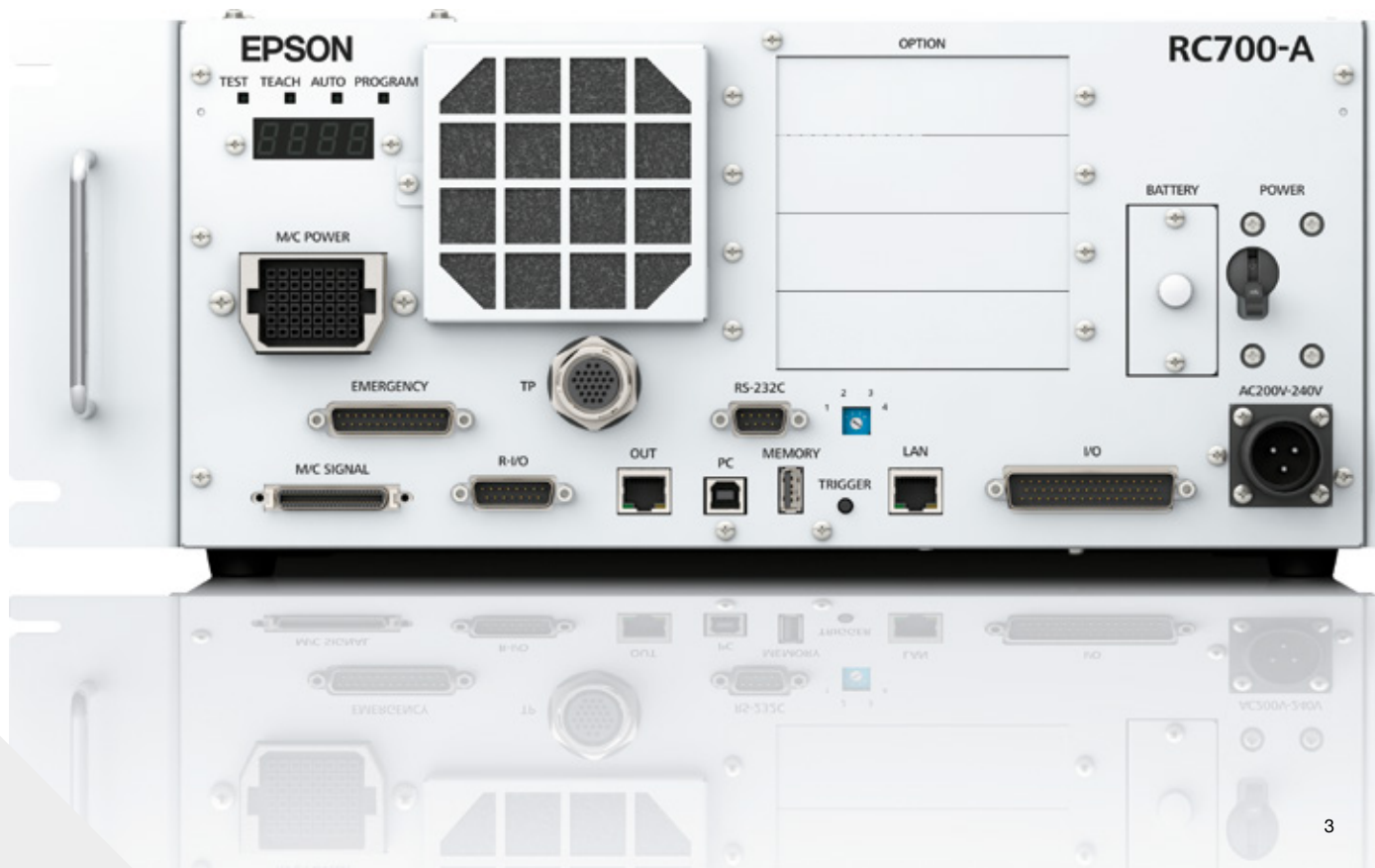

# Integrated concept, Simple networking

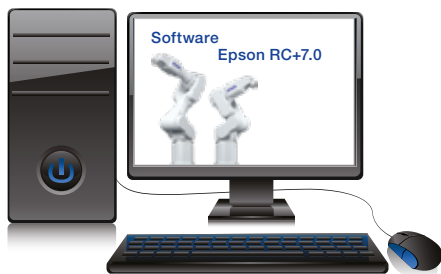

User configuration programs for personal computer

Epson RC+ 7.0 software program  
Simulator function

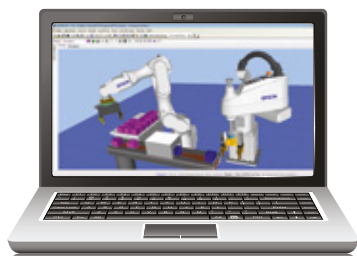

High-Speed Conveyor Tracking

## Expansion I/O cards

Serial RS-232C port  
Fieldbus cards  
Profibus master



## EPSON RC700-A Controller



## Image processing systems CV and PV



## Teach Pendant TP1



## Epson 6-axis robot (C4, C8 and N2 series)

Epson SCARA G series

Epson SCARA RS series



## Teach Pendant TP2



## Teach Pendant TP3



### **Open system architecture**

The Epson RC700-A can communicate with all conventional fieldbus systems. It can be connected to lower and higher level controllers, sensors, actors, conveyor belts and other peripheral devices. This means that the RC700-A can take over all robot, motion and process control functions – without the need for a PLC.

### **Multitasking specialist**

If several robots and peripheral devices are connected to the controller, the RC700-A's multitasking ability enables you to use your system more effectively and with fewer problems. Synchronisation takes place using markers and without additional wiring being required.

The RC700-A can process 48 multi-tasks. Of these 16 tasks can be used as background tasks – even if the robot program is interrupted. This multitasking ability means that even complex processes can be controlled easily within the work cell.

### **Networking at no extra cost**

Using the integral ethernet port, it's possible to connect the RC700-A to other Epson robot systems or company networks at no extra cost, so you can access the controller right from your desk.

### **RC700-A Drive units - benefits for manipulators**

Control a higher number of manipulators with one controller. The RC700-A drive units can control up to 4 manipulators with ease. This enables you to use tasks and markers to easily synchronise robots which work together in a single workspace.

The RC700-A drive units are available in two versions:

RC700-A DU4 for additional 4-axis robots

RC700-A DU6 for additional 6-axis robots

### **Various assembly scenarios**

Thanks to its compact size, the Epson RC700-A fits inside a control cabinet. It can also be installed in various positions – horizontal, vertical, on the floor, on the ceiling or on the wall.

### **Quick setup**

All the ports are located on one side, making it easier to connect the controller quickly and giving easy access for maintenance and repair work. The number of assemblies has been minimised to increase reliability. All components can be replaced without special tools.

### **Trigger key for backup**

Use of the trigger key enables to save a complete backup – including system status – to a USB stick. You can do this at any time whilst the system is running to make it possible to do simple offline error analysis.

# Expands flexibly to meet your needs

The expansion cards allow you to communicate with external devices and to integrate with fieldbus networks, so you can expand your system to the exact configuration you need for your application – from simple handling tasks to complete machine and robot control.

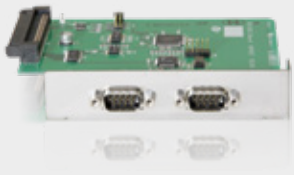

Max. two expansion cards  
Two channels per card

## RS-232C serial port card

The Epson RC700-A has a serial port for communicating with external accessories as standard. The serial expansion card enables you to use two additional channels (max. two expansion cards) so that a total of five channels are available.



Galvanic isolation of the inputs and output

An additional 24 inputs and 16 outputs per expansion card

Optical decoupling of the I/O cards

Protection against external influences such as excess voltage and electrostatic discharge

## Expansion I/O card

If the standard 24 inputs and 16 output aren't enough, and you don't want to create a fieldbus network, you can expand your system with a further 24 inputs and 16 outputs per expansion card. There's space for up to four expansion cards in total.



Profibus protocol stacks without loading the PC

Direct access to the process data in the dual port memory

Simple function control using LED status indicators

Save the configuration files to the internal flash

Provides 256 inputs and 256 outputs

Controls up to 1,024 inputs and 1,024 outputs (freely configurable) as Profibus master

## Fieldbus cards

To use a fieldbus system in your system or reduce wiring work, you can use the following slave cards with the RC700-A: Profibus, DeviceNet, CC-Link, ProfiNet and Ethernet IP. And, as a new addition, you can also use EtherCAT: the real-time Ethernet technology with nearly unlimited network expansion.

In addition, you can fit master cards, such as a Profibus master, in your PC. They record and control all the stations of the Profibus DP network as well as performing configuration, maintenance and diagnostic work for the network.

## Ergonomic, convenient and intuitive – portable control and display devices



### Teach Pendant TP1

This powerful, universal device performs all of the tasks pertaining to operation, display and teaching. Equipped with a high-contrast 4.0" TFT display.



### Teach Pendant TP2

A cost-effective introductory model which is compact and easy to operate.



### Teach Pendant TP3

A mobile terminal featuring an ergonomic casing with a brilliant and high-contrast 10" TFT-LCD display. Thanks to fast processors, it's perfectly suited for demanding visualisation and operating applications.

# High-speed conveyor tracking

Enables high-precision synchronisation with moving objects.

With the help of an image processing system, objects can be detected on the conveyor belt both in a linear direction and in a circular direction on a turntable. The robot picks them up without stopping the belt. An encoder measures the conveyor belt movement constantly. Even if the speed changes between detecting and handling an object, the robot can pick it up and put it down precisely.



### Multi-conveyor and multi-robot

The RC700-A supports up to 16 conveyor belts. These can be combined, in the conveyor tracking system, with all the robots connected to the controller. The objects found on the conveyor belts are placed in intelligent queues and processed in parallel by several robots without the operator having to intervene.

### Sensor tracking

Instead of detecting the position of an object with a camera, the conveyor tracking system is triggered by a sensor, such as a light barrier. When the object enters the robot's pick-up range, the robot can pick it up precisely.

### PG motion board

The board is primarily used to read the speed of the conveyor belt using an encoder. Software options mean that it can also be used to control kinematic systems which don't use Epson components. Both step motors and servo motors are supported.



4 channels per card

Max. 4 cards possible

**Front view**

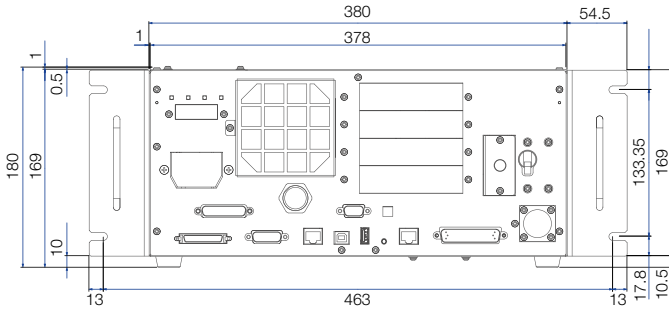

**Package**

- 1 Epson RC700-A controller
- 1 Epson RC+ program CD including simulator
- 1 set of mounting brackets for the robot controller
- 1 set of 3m motor and signal cables
- 1 plug for Emergency Stop
- 1 plug for standard I/O
- 1 USB programming cable
- Manuals on CD
- 1 Installation / Safety manual

A gap of 200 mm at the front and 100 mm in all other directions should be left clear for the air flow and the outgoing cables.

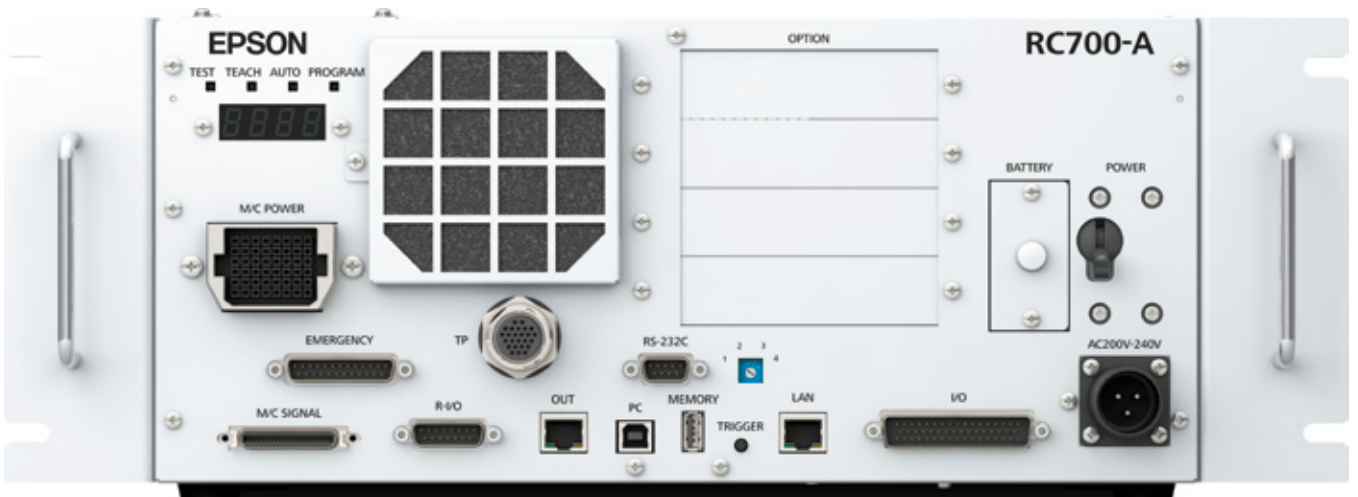

**View from below**

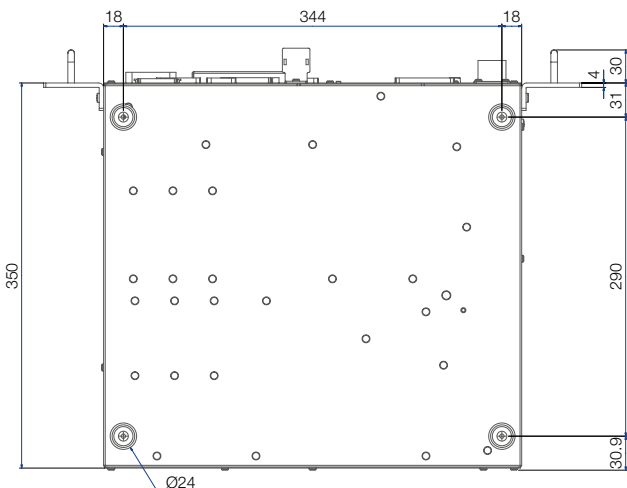

**Side view**

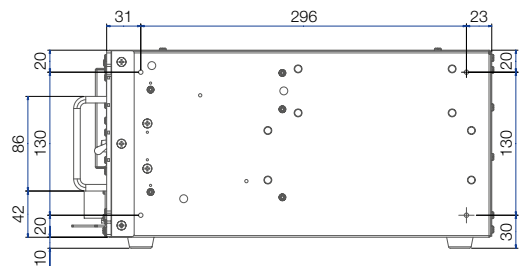

Dimensions excluding cable connection



# Technical data for Epson RC700-A

Ports	1x USB memory, 1x USB device 1x 10/100 base T-Ethernet 24/16 Standard I/O channels – 8/8 as Remote RS-232C Standard 1x channel
CPU	32-bit Microprocessor
Hardware options	<b>Control and display devices</b> Teach Pendant 1 (TP1) Teach Pendant 2 (TP2) Teach Pendant 3 (TP3) <b>Drive Unit</b> 1 Robot Manipulator per drive unit, 2 additional drive units possible
Expansion card options	<b>I/O expansion</b> 24/16, 4 additional cards possible <b>I/O fieldbus master cards</b> Profibus, DeviceNet, Ethernet/IP, 1 additional card of each type possible <b>I/O slave fieldbus cards</b> Profibus, DeviceNet, ProfiNet, Ethernet/IP, CC-Link, EtherCAT, 1 additional card of each type possible <b>RS-232C serial port</b> 2 channels per card, 2 additional cards possible <b>Pulse Generator Motion card</b> 4 channels per card, 4 additional cards possible
Software options	RC+ API 7.0 previously VB Guide External Control Point Motion (ECP) GUI Builder 7.0 Force Sensing Security Option
Development environment	Epson RC+ 7.0
Programming language	Epson SPEL+ 7.0 multitasking-capable
Connection values	<b>One-phase</b> AC 200 V to 240 V <b>Two-phase</b> AC 110 V to 120V, 50/60 Hz
Power consumption	Up to 2,500 VA – depending on manipulator model
Ambient temperature	5–40°C
Relative humidity	20% to 80% – non condensing
Safety equipment	Emergency stop button, safety door entry, low power mode, generator brake <b>Error detection</b> Encoder cable break <b>Detectors</b> Motor overload, motor speed error, irregular motor torque (manipulator out of control), overheating of a motor driver module, positioning overrun – servo error, speed overrun – servo error, CPU error, memory checksum error, relay drop-out, excess voltage, mains voltage outage, temperature deviation, fan error
Certifications	CE ANSI RIA R15.06 -1999 EC Maschinenrichtlinie 2006/42/EC
Dimensions	380 x 350 x 180mm
Weight	11 kg

# Powerful, efficient, intuitive: Epson RC+ 7.0 development environment

With its intuitive Windows interface, open structure and integrated image processing, the powerful Epson RC+ 7.0 project management and development environment makes programming your applications straightforward.

The software is capable of controlling all kinds of robots and functions. It also supports a graphic 3D environment which enables you to visualise robot motions and simulate the robot program almost completely.

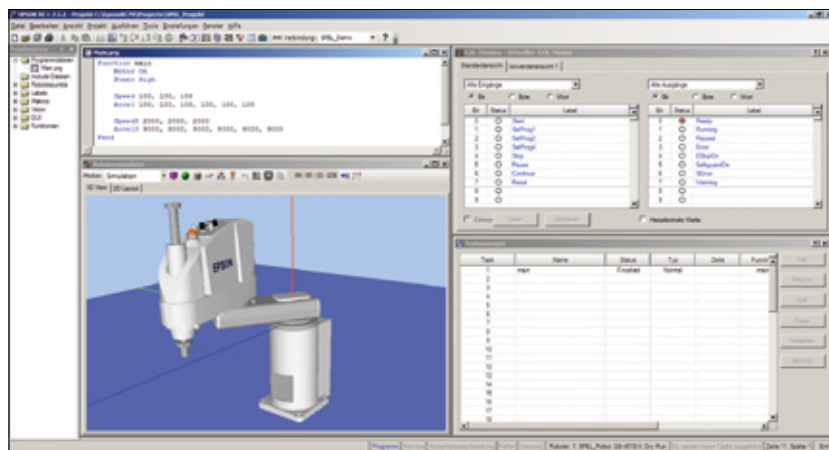

## We make it simple

As soon as you enter inputs, for example movement and I/O instructions, the system displays familiar designators on pull-down menus to make the programming process easier. You can access an extensive help system using the F1 help key you'll recognize from Windows. Every command is described along with its parameters. What's more, there are also links to related commands and examples which can be copied and pasted into your project.

## Features & advantages

Runs in Microsoft Windows XP, Windows Vista and Windows 7

Integrated project management system for fast project development

Communicates with the controller via USB or Ethernet

Enables you to connect one computer to multiple controllers

Parallel operation of multiple RC+ 7.0 applications possible (one computer accesses multiple control units in parallel)

SPEL+ programming language: powerful, easy to learn and use

Intuitive operation

Image processing integrated in the interface

Wide-ranging port connection: Ethernet I/O, Profibus, DeviceNet, ProfiNet, serial port, TCP/IP, I/O Handshake direct or available as an option

Programming environment available in German, English, French, Japanese and Chinese

Background tasks for complete system control

Extensive multi-manipulator commands

Integration of DLL functions

Simulator

File management



### New functions

The Epson RC+ 7.0 follows on from the Epson RC 5.0 and RC 6.0, and features lots of new functions, including:

**Lifetime prediction:** Industry 4.0. Predictive planning of maintenance intervals for core components

**Vision simulation** to simulate and test image processing sequences

**Catch-on-fly** for image capture and analysis without stopping the robot

**Defect inspection** – image processing function to identify defective parts

**Support** for colour and high resolution cameras

**CAD-to-Point** to convert CAD data to robot points

**Test mode** e.g. running the program with the safety door open using the enable key

**Support** for Epson QMEMS® sensor technology

### Software options

#### Conveyor Tracking

Position synchronisation whilst the conveyor is running.

#### External Control Point (ECP)

You decide the coordinates: with ECP you can guide the workpiece contour easily and precisely along an external point.

#### Force sensing

Allows the force of the robot to be measured in real-time.

#### GUI Builder

Quickly and easily create your own user interface based on Epson programming language SPEL+.

#### Optical Character Recognition (OCR)

OCR identifies fonts and symbols reliably and controls the print – even in difficult conditions.

#### PG Motion System

Read conveyor speeds via encoders.

#### RC+ API

RC+ API enables you to integrate your application in external software to develop user interfaces and databases.

#### Security Option

Greater security by user management and usage control.

#### Vision Guide 7.0

Efficient Epson image processing system.

Suitable for the whole automation lifecycle

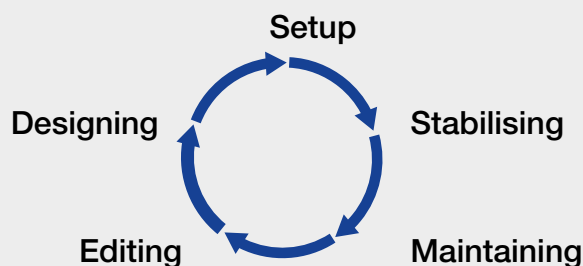

# We're fluent in SPEL

Specially developed by Epson, this line-based SPEL+ script language is not only powerful but also easy to learn. Its range of commands enables you to program a very wide variety of robot motions – from a simple pick and place application to complex multi-manipulator line control.

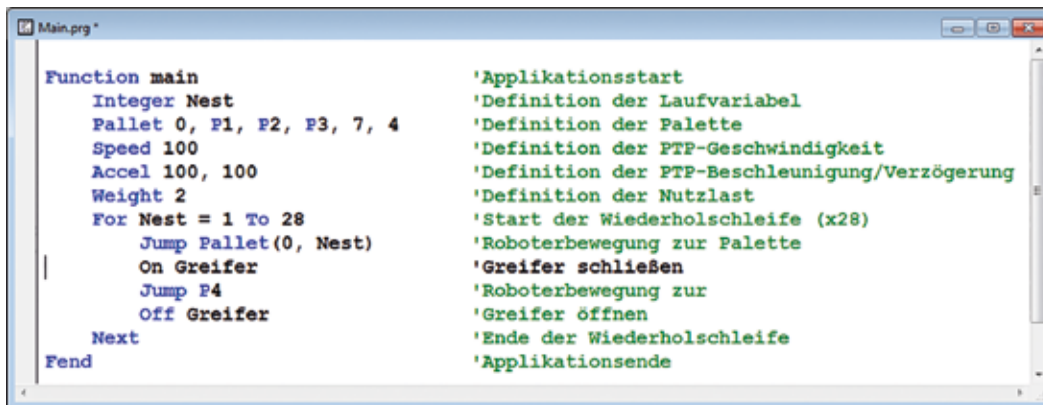

```
Function main                                     'Applikationsstart
Integer Nest                                       'Definition der Laufvariabel
Pallet 0, P1, P2, P3, 7, 4                       'Definition der Palette
Speed 100                                         'Definition der PTP-Geschwindigkeit
Accel 100, 100                                   'Definition der PTP-Beschleunigung/Verzögerung
Weight 2                                          'Definition der Nutzlast
For Nest = 1 To 28                               'Start der Wiederholschleife (x28)
  Jump Pallet(0, Nest)                          'Roboterbewegung zur Palette
  On Greifer                                     'Greifer schließen
  Jump P4                                         'Roboterbewegung zur
  Off Greifer                                    'Greifer öffnen
Next                                              'Ende der Wiederholschleife
Fend                                             'Applikationsende
```

## Complete high-language SPEL+

### Fast and secure

SPEL+ is translated into a robot code by a compiler. This is carried out faster than using an interpreter and the syntax can also be checked before the program is run.

### More flexibility

The extensive range of comments for various applications means short programming time with many fewer errors. You can add your own commands using the SPEL+ syntax.

### Clearly structured

In addition to program structure commands you can also use sub-program techniques, multi-tasking and interrupt commands to write programs which are easy to read and easy to enhance and expand.

### Communicative

Whether it is for easy handling of inputs and outputs, communication via the serial TCP/IP port or exchange data in a fieldbus system – SPEL+ minimises the programming work.

### Intuitive to learn

SPEL+ has no cryptic codes and uses real values.

### Simple to transfer

SPEL+ syntax can be transferred to various .Net products. It also has an interface to Labview.

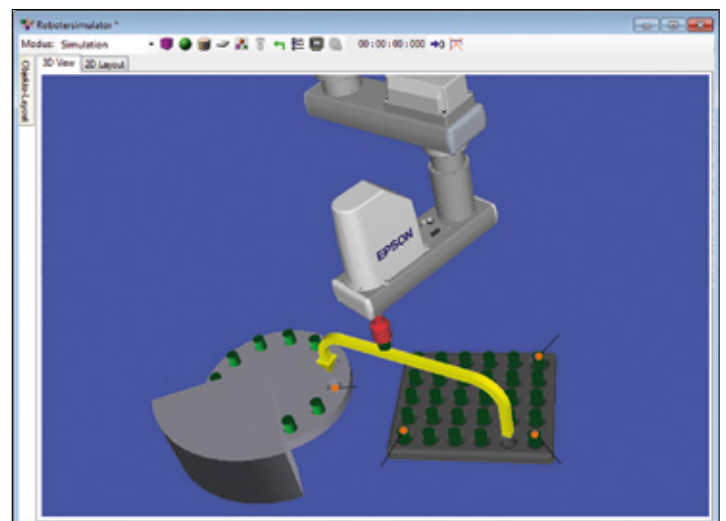

Even complex pallet layers can be easily set up and processed with the pallet command. There's no need to teach every single network, so you'll save time and get more reliable results.

In addition to PTP (point-to-point), LINEAR MOTIONS, CP (continuous path) and more, SPEL+ also covers a series of other commands such as JUMP or PALLET.

# Software tools for the Epson RC+ 7.0 development environment

It's great when even complex projects are made simple. The tools for the Epson RC+ 7.0 development environment give you everything you need to program your application efficiently.

## **Command**

One-line command editor

## **Compiler**

Check the programs  
(syntax, definition, value range, etc.)

## **Debugger**

Program with stop points / step mode

## **DLL Functions**

Access to external DLL functions

## **Editor**

Create SPEL+ programs:  
Online help, syntax check, label lists, detection and colour display of keywords, parameters and comments, parameter list, definition jump

## **Error text editor**

Creation of your own error messages for specific application

## **File management**

Create and access files and databases (Excel, Access, SQL)

## **IO Label Editor**

Edit names for I/O / markers / fieldbus I/O for the data sizes bits, byte and word

## **IO Monitor**

Display the status of I/O / markers / fieldbus I/O for the data sizes bits, byte and word. Special application displays can be created.

## **Macro Editor**

Create SPEL+ program as a programming aid

## **Robot manager**

Contains all information and control elements relevant to robots - inserted in clear windows:  
Set-up, edit points, loop parameters, tool and robot coordinate systems, load capacity and moment of inertia. The robot trip points can be used to switch motors on and off, complete a reset or complete a home run.

## **Stackeditor**

Display the program branches

## **System History**

Recording of errors, events and warnings (Diagnostics)

## **Task Manager**

Display the open multi-tasks, traps and their status, display the current program line

## **Variable editor**

Display / edit the current variable values

## **Maintenance manager**

Create / load / display backups, controller reset

## **Simulator**

Planning and visualisation of processes, program validation



# Simulation of robot cells

Good preparation is everything. Plan and visualise all procedures in your production, validate your program offline initially and carry out troubleshooting and editing work easily from your desk. With the Epson RC+ Simulator – included in the software package – you save time and money through all phases of your project.

## Phase 1 Design

Plan your robot cell at full size in advance and work out the expected cycle time for your application to check feasibility before a single part for the system has been made. Plan future system expansions in the simulation system to keep downtime to a minimum.

## Phase 2 Integration

Completing the program validation process before the robots are delivered enables you to create programs at the same time, with the system capable of displaying and evaluating even complex motions. Collision risks are identified and equipment damage is prevented.

## Phase 3 Operation and maintenance

Troubleshoot and modify programs from your desk. Use the 3D layout to visualise collision detection, reachability checks and robot motions.

## Even simpler designs using the CAD-to-Point function

The CAD-to-Point function allows CAD data to be converted into robot points.

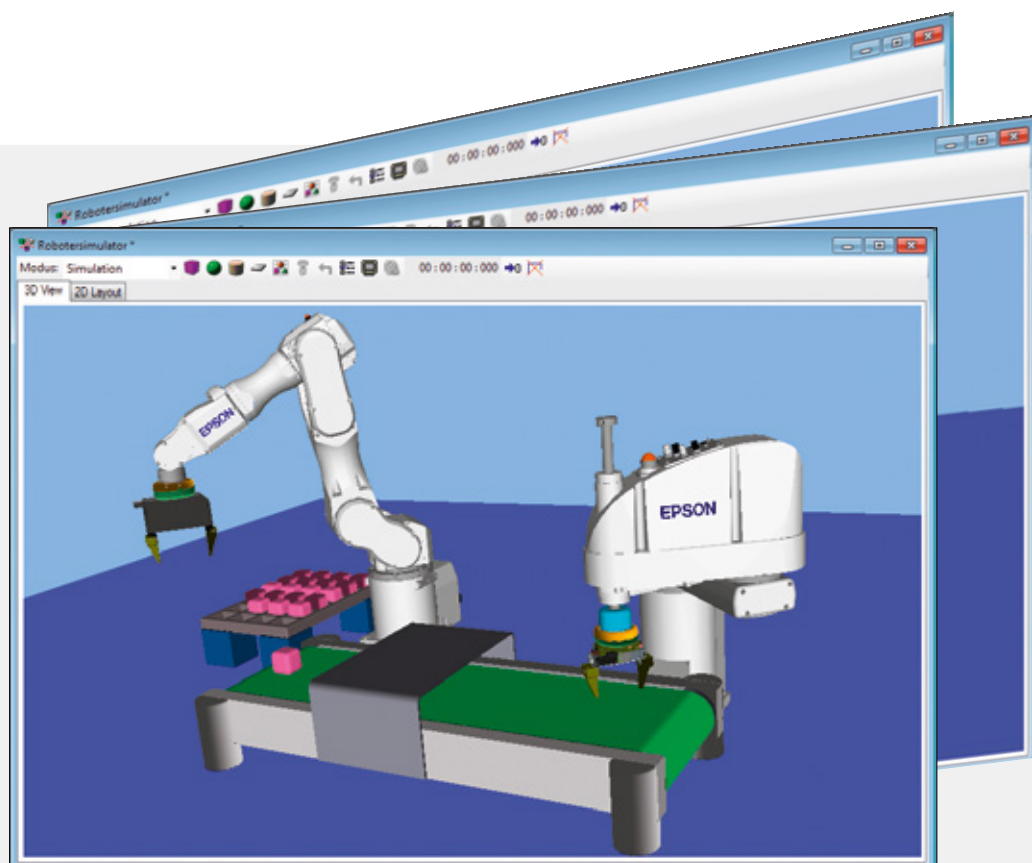
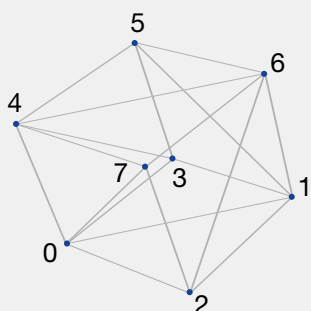

# About Epson

Epson Robotic Solutions is one of the leading suppliers of high tech robot systems that are renowned worldwide for their reliability. The product range includes six-axis robots, SCARA robots, the SCARA entry-level LS and T models, the special Epson-developed Spider and N2 robots types, as well as the pioneering Dual Arm robot. Added to this are image processing controls and the Epson Force Sensor for force-controlled applications.

This gives Epson Robotic Solutions one of the most comprehensive ranges of high-precision industrial robots in the world, making them a technological pioneer for intelligently controlled automation processes.

## Technological pioneer

### 1982

Epson SCARA robots freely available in Japan for the first time

### 1986

First class 1 cleanroom robot

### 1997

First PC-based controller

### 2008

Inventor of the right or left arm-optimised G3 SCARA robot

### 2009

Inventor of the spider – a unique SCARA robot with no dead zones

### 2013

First application of Epson QMEMS® sensors in robotics, reducing six-axis kinematics vibrations

### 2014

Epson Compact Vision CV2: Epson's own ultra-fast image processing computer

### 2016

Epson N2 series: World's first 6-axis robot with folding arm - extremely compact and space-saving

### 2017

Epson Dual Arm robot with an arm geometry inspired by human physiology, as well as integrated sensors such as cameras, force sensors, and accelerometers

## Pre and after-sales support

Feasibility studies for maximum planning and project security

Support for planning and implementation

Introductory seminars, programming/maintenance courses, operator training

Inspection and individual maintenance concepts

Hotline service, on-site repair service

Central spare part stocking

# Epson Industrial Solutions Centre – find your solution



Experience all our Epson robots in action. Build, simulate and improve your automation application in a workshop cell, with help from our experts. The cell can be controlled and networked using all conventional fieldbus systems. In addition, we can supply you with modern peripherals such as a vision and conveyor tracking system.

## Make an appointment

Call us on  
**+49 2159 538 1800**

or send an email to  
**info.rs@epson.de**

Epson Deutschland GmbH  
Robotic Solutions Division  
Otto-Hahn-Straße 4  
40670 Meerbusch

Phone: **+49 2159 5381800**  
Fax: **+49 2159 5383170**  
E-Mail: **info.rs@epson.de**  
**www.epson.de/robots**

Epson America Inc.  
[www.epsonrobots.com](http://www.epsonrobots.com)

Seiko Epson Corp  
<http://global.epson.com/products/robots/>

Epson China Co, Ltd.  
[www.epson.com.cn/robots/](http://www.epson.com.cn/robots/)

A6757\_C\_R0700A\_EN-INT-01/18  
For further information please contact your local Epson office or visit [www.epson-europe.com](http://www.epson-europe.com)

Algeria (+2213) 770 938 617 Austria 01 253 49 78 333 Belgium +32 (0)2 792 04 47 Czech 800/142 052 Denmark 44 50 85 85 East Africa (+254) 734 354 075  
Finland 0201 552 091 France 09 74 75 04 04 (Cost of local call, operator charges may apply) Germany +49 (0) 2159/92 79 500 Greece (0030) 211 198 62 12  
Hungary 06800 147 83 Ireland 01 436 7742 Israel (+972)-3-5751833 Italy 02-660321 10 (0,12 €/min) Luxembourg +352 27860692 Middle East +9714 2677638  
Morocco (+212) 661 31 11 18 Netherlands +31 (0)20 708 5099 Norway +47 67 11 37 00 Poland 0-0-800 4911299 (0,16 zł/min) Portugal 707 222 111  
Russia (095) 777-03-55 Slovakia 0850 111 429 Southern Africa (+2711) 465-9621 Spain 93 582 15 00 Sweden 0771-400135 (Mobilsamtal – 0,99 kr/min,  
Lokala samtal – 0,30 kr/min, Utlandssamtal – 0,89 kr/min) Switzerland 022 592 7923 Tunisia (+216) 9833 3571 Turkey (0212) 3360303  
United Kingdom 0871 42 37766 West Africa (+234)8020727843

Trademarks and registered trademarks are the property of Seiko Epson Corporation or their respective owners.  
Product information is subject to change without prior notice.

**EPSON®**