

Vision systems

# Reliable and accurate vision systems



**EPSON®**  
EXCEED YOUR VISION

# Powerful all-in-one software for multiple applications

Product quality is an important competitive issue across all industries. Retrospective quality validation is both time consuming and costly, causing the manufacturer to have to go back and evaluate its manufacturing process to see what went wrong. Effective quality control during the production process not only achieves transparency and efficiency in the production chain, it also ensures defective parts are extracted within the process at their point of origin.

Epson robots with the powerful Epson Vision System allows manufactures to focus on quality from the outset. Micro-defects on visible, sealing and functional surfaces, as well as component contours can be easily detected. Even with high clock rates, poor accessibility and narrow component tolerances.

In addition to quality assurance, Epson Vision System can also be used across a wide range of other applications such as dynamic, flexible parts handling and conveyor tracking, as well as component orientation and pick and place applications.

Epson Compact Vision CV2



# Just in time Just for me



- Reliable quality control even with very narrow tolerances
- Improved production process transparency
- Minimise operating costs by lowering intervention
- Reduce defects and maintain continuous operation at all times
- Improve product tracking
- End-to-End automation, even with complex parts handling

# Industry solutions

Whether you are using robots for handling, testing, machining, measuring or inspecting, the image processing has increasing importance within the robotics. The Epson image processing system, made up of software tools, hardware and compact cameras can be precisely tailored to suit specific applications - enabling manufacturing quality at the highest level.

## Medical / Pharmaceutical Automated pipetting of substances



The Epson SCARA cleanroom robot has an integrated mobile camera that inspects different areas and allows precision corrections. Even if the target part is not in the same location, its camera guidance capabilities enable precision dosage and grip positions.



A second camera carries out quality inspections to check whether the dispensed droplets are in the correct position and size.

## Electronics industry Headlamp drives assembly



Thanks to its inherently flexible movement and gripping ability, the Epson 6-axis robot with image processing capabilities, can detect the exact part location and carry out an inside contour check, both of which can be easily controlled via a software platform.



Variable mounting positions allow the robot to detect the perfect shape and exact dimensions, offering maximum flexibility for short product cycles in manufacturing.

## Automotive industry Camera-guided 3D assembly and MID module testing



The three-dimensional MID (Moulded Interconnect Devices) technology mechatronic assembly can be fitted, tested and assembled using Epson robots equipped with a mobile camera.

Production data is acquired via the master computer to ascertain data matrix codes and ensure accurate rendering.



A mobile camera enables high-frequency 3D dispensing of soldering pastes on both horizontal and inclined surfaces, minimising the need to reposition surfaces and keeping production running smoothly. Dispensing points are optically checked to adjust the dispense path if necessary. Following final assembly of the combination switch and cable assembly, a haptic, optic and electrical functional test is then carried out for quality control.

# Smarter and faster image processing

Epson Vision System seamlessly integrates kinematics, controller and image processing, allowing for rapid communication between the robot and image processing function.

## Epson Compact Vision CV1: Your entry to image processing

Combine up to eight standard or high resolution USB cameras in a permanent or mobile installation, using both integrated or offset lenses

View objects at a variety of focal lengths giving you precise control and visibility

Ideal in environments where a computer is not always used for image processing



USB  
(or Ethernet)



Epson robot controller

## Epson Compact Vision CV2: High-speed image processing

Ideal when there is no computer required to process images

Highly effective for tasks that require short cycle times and a high camera resolution (more than 1.3 MP) in both colour and monochrome

Combine up to four GigE cameras and two USB cameras, either mobile or stationary

High-speed communication via GigaEthernet

Available as one of two variants: the standard CV2-SA, or the CV2-HA for more demanding requirements



USB  
(or Ethernet)



Epson robot controller

## Epson Compact Vision PV1: Image processing system via PC

Combine up to eight GigE cameras, either mobile or stationary

High-speed communication via GigaEthernet makes it ideal for short cycle times and high camera resolutions (more than 1.3 MP) in both colour or monochrome

Requires a computer for image processing



Epson robot controller

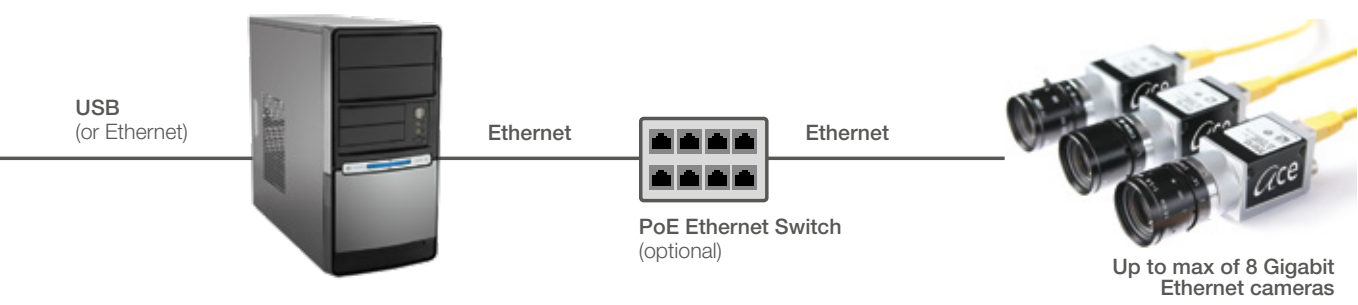
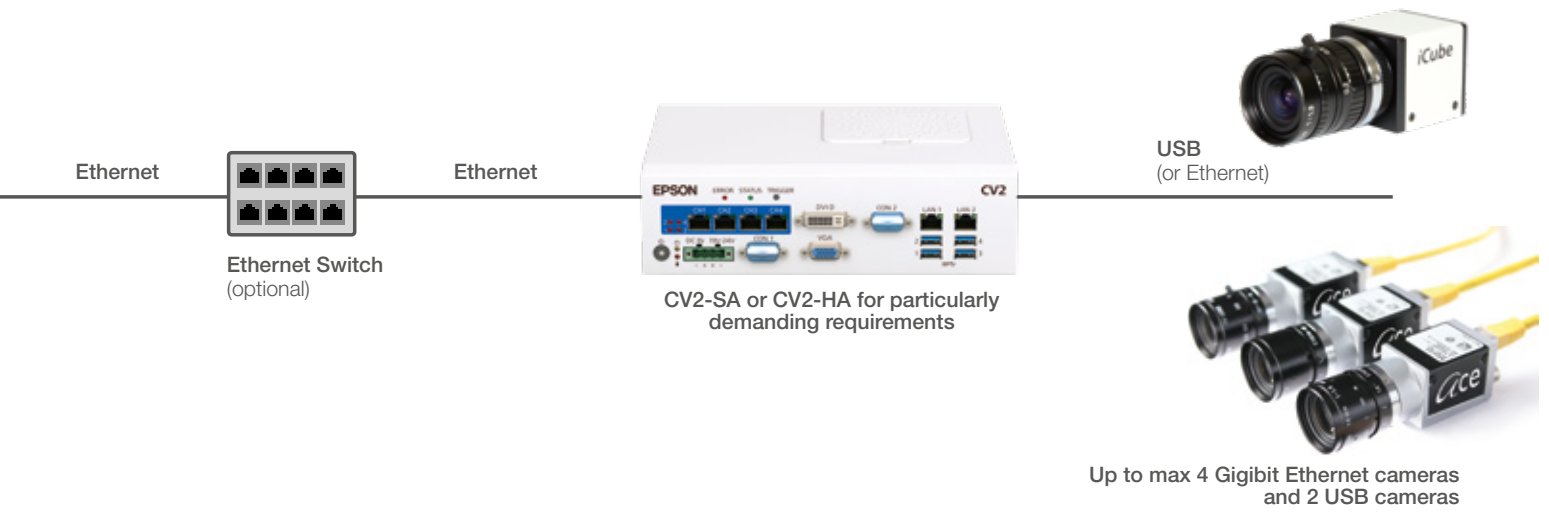
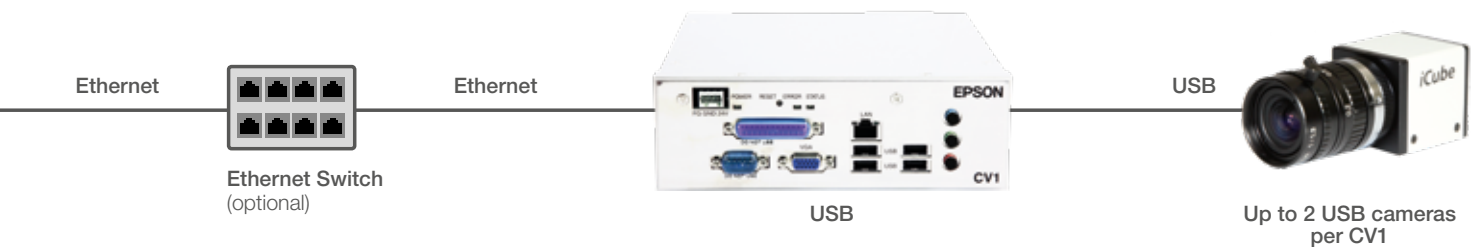

# Image processing systems



Epson Compact Vision	CV1	CV2-S	CV2-H
Processor	–	Intel Pentium G2120	Intel Core-i7 3770
Ports	Ethernet, USB, monitor, mouse, keyboard		Ethernet, USB 2.0, monitor, mouse, keyboard
Camera connections	Max. 2 USB cameras	Up to 4 GigE cameras and 2 USB cameras (6 cameras max.)	
Dimensions	190 x 63 x 197mm	232 x 70 x 175 mm	
Power consumption	DC 24V ±5%/2A	DC 24V ±5%/12A	
Ambient temperature	5 – 40°C	5 – 40°C	
Weight	1.5 kg	2.1 kg	

b/w image processing

b/w and colour image processing



Epson USB cameras for Compact Vision (CV1 AND CV2)	USB VGA Mono camera	USB 1.3M Mono / colour camera	USB 5.0M Mono / colour camera
Resolution	640 x 480 pixels	1,280 x 1,024 pixels	2,560 x 1,920 pixels
Sensor types	CMOS – 1/3" Progressive Scan	CMOS – 1/2" Progressive Scan	CMOS – 1/2,5" Progressive Scan
Lens attachment	C / CS mount		
Camera use	Stationary camera 5m USB cable, Mobile camera 5m USB high flex cable		
Accessories (optional)	1x set of mounting brackets, lenses, individual 8, 12, 16, 25, 50mm, or as a set, 1x set of intermediate rings		
Dimensions without lens	33 x 30.5 x 30mm		
Weight	50g		

b/w image processing

b/w and colour image processing



Epson GigE-Cameras for PC Vision (PV1) and Compact Vision (CV2)	GigE VGA Mono camera	GigE 2.0M Mono / colour camera	GigE 5.0M Mono / colour camera
Resolution	640 x 480 pixels	1,600 x 1,200 pixels	2,560 x 1,920 pixels
Sensor types	CCD – 1/4" Progressive Scan Global shutter	CCD – 1/1.8" Progressive Scan Global shutter	CMOS – 1/2.5" Progressive Scan Rolling shutter
Lens attachment	C / CS mount		
Camera use	Stationary camera 5m Gigabit Ethernet cable Mobile camera 5m Gigabit Ethernet high flex cable		
Accessories (optional)	1x set of mounting brackets, lenses, individual 8, 12, 16, 25, 50mm or as a set, 1x set intermediate rings, 10m Gigabit Ethernet cable, 10m Gigabit Ethernet high-flex cable		
Dimensions without lens	42 x 29 x 29mm		
Weight	90g		



Front view (CV1)

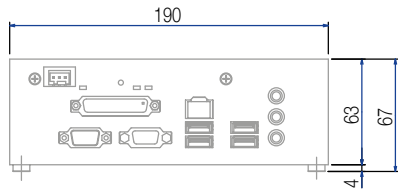

Rear view (CV1)

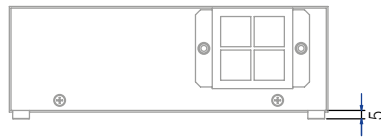

Front view (CV2)

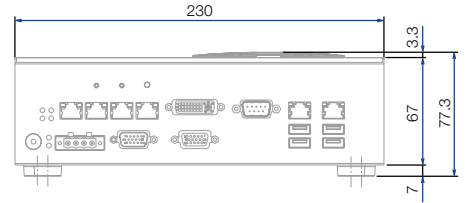

View from below (CV1)

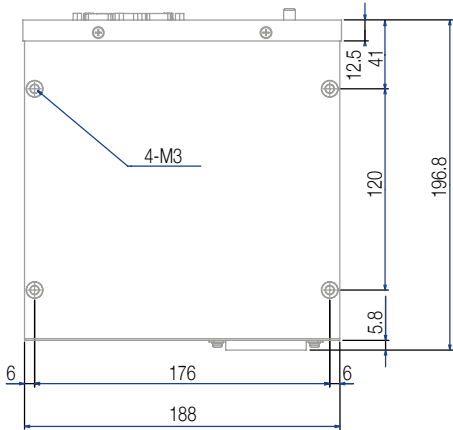

Rear view (CV2)



View from below (CV2)

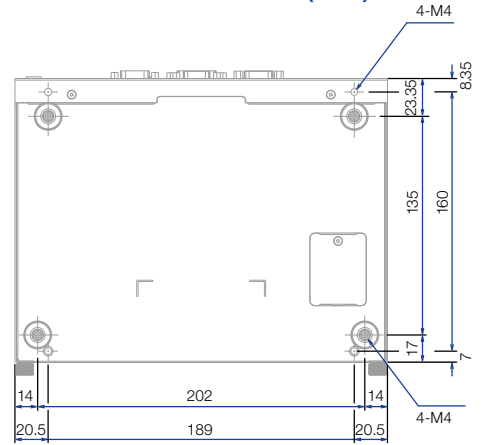

Front view

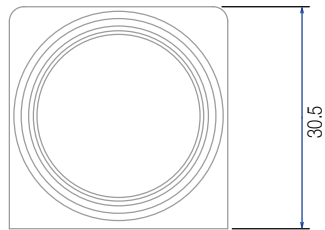

View from below

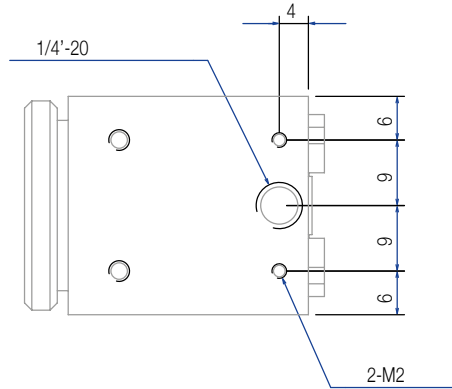

Rear view

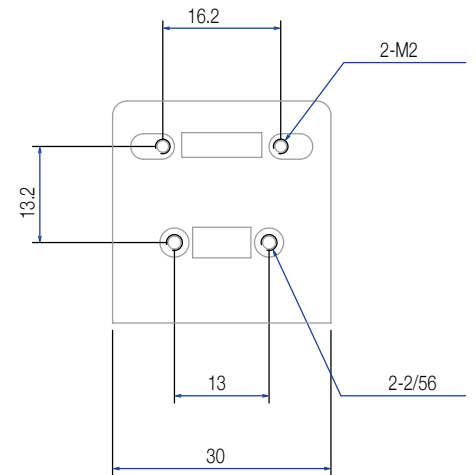

Front view

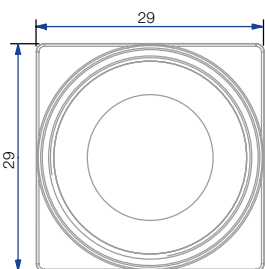

View from below

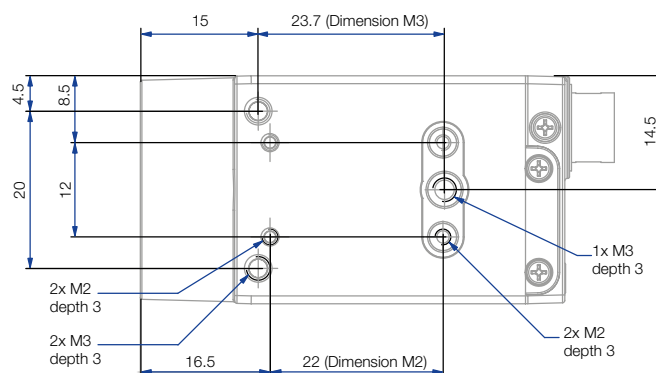

Rear view

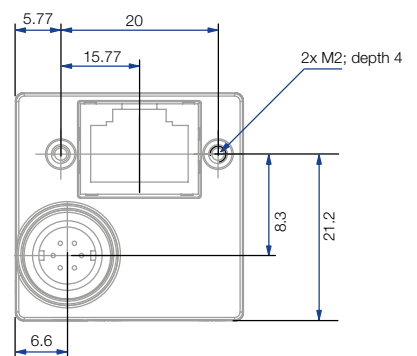

# Configurable software tools made to order

## Simple programming

Epson Vision Guide 7.0 is integrated within the Epson RC+ development environment, significantly reducing setup times and allowing image processing sequences to be created in just a few clicks. Programming uses drag and drop without the need for additional editors or advanced software programming knowledge. The software runs on Windows (XP, Vista, 7 and 8.1) and communicates with the control via USB or Ethernet.

## Help when you need it

An intuitive setup wizard guides you through the set up process, making image processing integration even easier.

# Gain more control and vision with Epson Vision Guide 7.0

## Image processing simulation

Simulate image processing sequences prior to robot system configuration, and gain valuable experience with the operating environment.

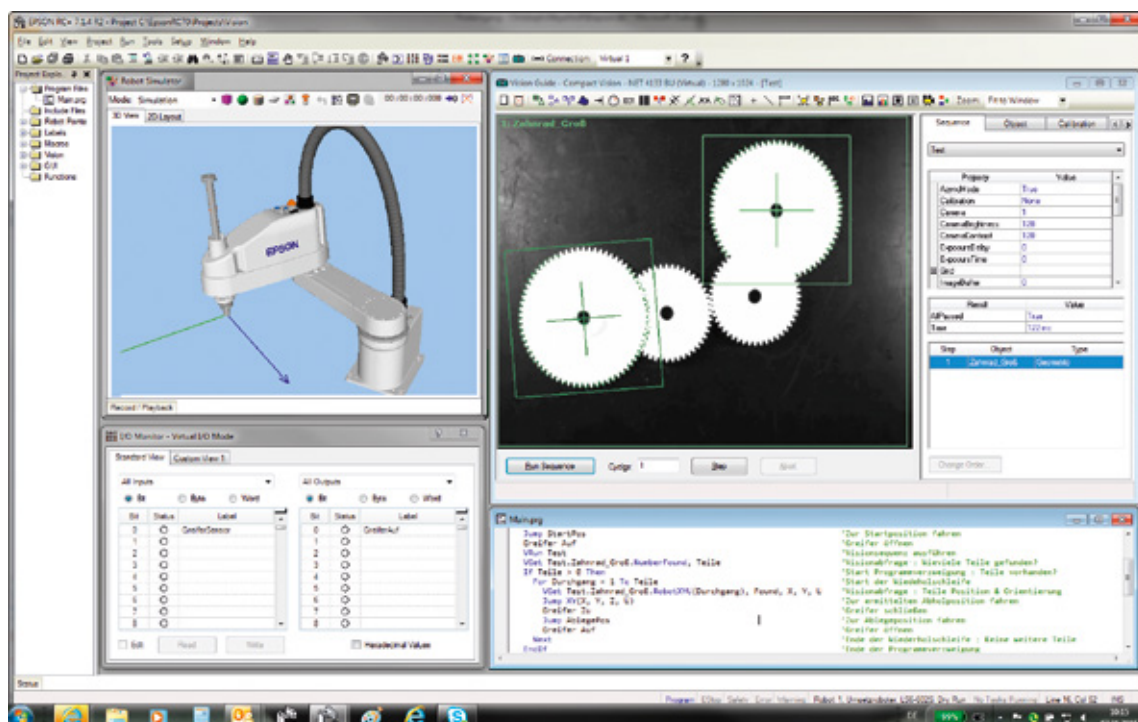

### Real-time recording and evaluation

The robot controller captures the image and evaluates it, allowing data to be analysed and defects detected quickly, all completed without interrupting the robot in action.

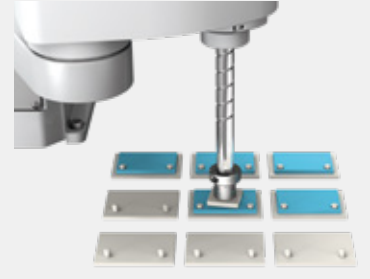
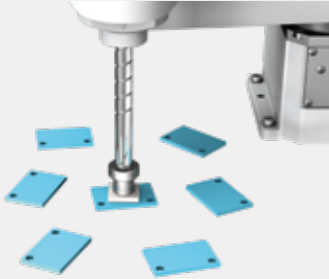

### Inspects defects

Epson Vision Guide has a highly flexible defect inspection function that can be used in visual inspections or to detect flaws against pre-defined specifications or templates, even on complex shapes. This provides peace of mind for final quality inspection.

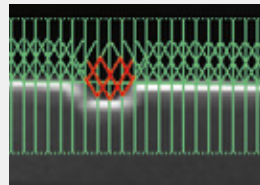

Line inspector

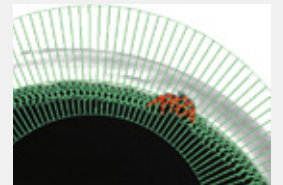

Curve inspector

### Colour camera support

Our vision system cameras can be used to identify and select coloured or transparent workpieces, enabling the assessment of the front and rear of each piece, giving you greater flexibility in production planning.



### High resolution camera support (2 MP / 5 MP)

These high-resolution, high precision cameras offer a wider search area to quickly eliminate defects and improve productivity.



0.3 MP



5 MP

# Configurable software tools made to order

## Geometric object matching

The Geometric Object software tool enables you to detect, align and match objects much faster and more reliably than conventional template or edge detection. Vision inspection commands are selected from a library to eliminate the complex and often lengthy multiple command sequences.

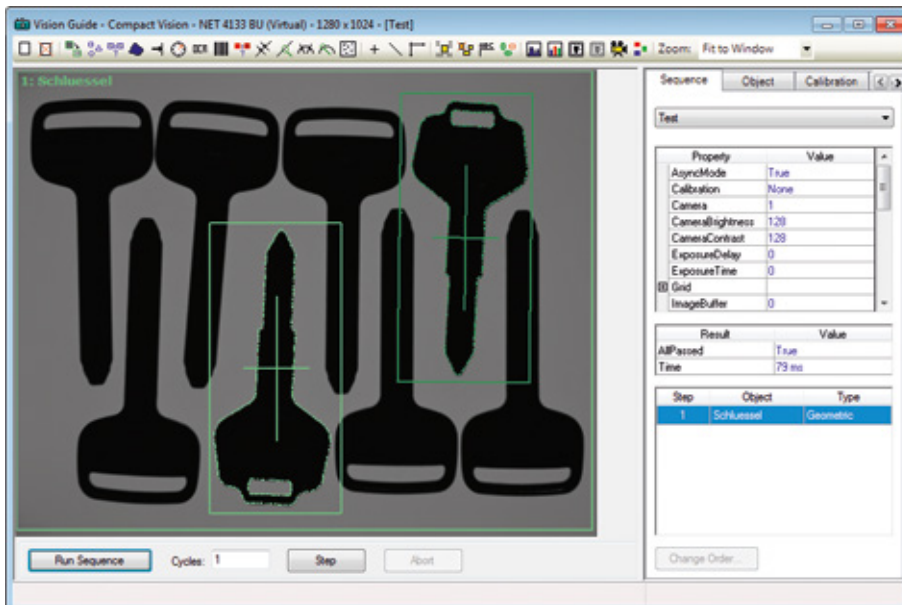

## Code reading

Barcode, data matrix codes and QR codes can be quickly identified to allow better and faster product tracking.

Barcode



EAN 8



QR



## Accurate and reliable software tools - at a glance

**Integrated calibration routines** which support various camera alignments and calibrations

**Point and click interface** for faster prototyping

**Blob analysis tools** to measure the size, form and position of objects

**Search function** for geometric figures based on geometric part elements

**Normalised correlation search** to detect objects using a sophisticated template matching technique in varying light conditions

**Edge search function** to measure distance, diameter and total count at sub-pixel level

**Polar search and angle search function** to quickly measure the rotation of complex objects

**Line and point tools** draw and measure lines between points

**Object reference mechanism** to align multiple vision tools together

**Histograms** for analysing pixel data and defining limit values for tools

**Statistical calculations and evaluations** for every vision tool

**Automatic compensation** of small defects on the camera lenses for object angle deviations

**Catch-on-fly motion control** via I/O function without stopping the robot

**Vision simulation** for simulating complete motions

**Defect inspection** to compare objects with template images

**Code reading** for the identification of barcodes and two dimensional data matrix codes without having to be explicitly learned

**Support** for colour cameras and high resolution cameras

# About Epson

## **Epson robot systems. Accurate, fast and reliable**

Our robots palletise, saw, mill, drill, grind, install, assemble and build together. They work with precision and at breathtaking speeds across a wide range of applications, often up to 24 hours a day.

Our product range includes one of the most comprehensive SCARA model ranges worldwide; 6-axis robots, controls and software.

## **Realise the full potential of your Epson Robot systems**

We offer a comprehensive pre and after sales support programme as part of our service. This includes:

Feasibility studies for maximum planning and project security

Support during planning and implementation

Introductory seminars, programming/maintenance courses and operator training

Inspection and customised maintenance designs

Customer service telephone service and on-site repair service

Central spare part stocking



## **Epson Spider robot**

The cost effective miracle  
Due to its unique construction, the Epson Spider reaches every corner of its working area at unprecedented cycle times.



## **Epson SCARA robots**

Available in over 400 versions, Epson SCARA robots are compact and powerful, delivering precise work even at high speeds.

Epson Robotic Solutions is one of the leading suppliers of high tech robot systems that are renowned worldwide for their reliability. The product range includes six-axis robots, SCARA robots, the SCARA entry-level LS and T models, the special Epson-developed Spider and N2 robots types, as well as the pioneering Dual Arm robot. Added to this are image processing controls and the Epson Force Sensor for force-controlled applications.

### Technological pioneer

#### 1982

Epson SCARA robots freely available in Japan for the first time

#### 1986

First class 1 cleanroom robot

#### 1997

First PC-based controller

#### 2008

Inventor of the right or left arm-optimised G3 SCARA robot

#### 2009

Inventor of the spider – a unique SCARA robot with no dead zones

#### 2013

First application of Epson QMEMS® sensors in robotics, reducing six-axis kinematics vibrations

#### 2014

Epson Compact Vision CV2: Epson's own ultra-fast image processing computer

#### 2016

Epson N2 series: World's first 6-axis robot with folding arm - extremely compact and space-saving

#### 2017

Epson Dual Arm robot with an arm geometry inspired by human physiology, as well as integrated sensors such as cameras, force sensors, and accelerometers

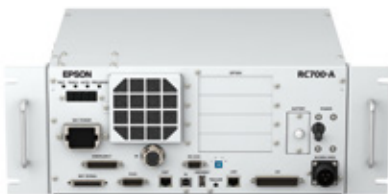

### Epson controls

Maximum performance in the smallest of spaces. The Epson controllers are based on a robust, integrated system, and can control manipulators and peripheral devices.



### Epson 6-axis robot

Flexibility through rotary-designed axes. Thanks to unprecedented point and path accuracy, complex work processes can be achieved with precision.

# Epson Industrial Solutions Centre – find your solution



Experience all our Epson robots in action. Build, simulate and improve your automation application in a workshop cell, with help from our experts. The cell can be controlled and networked using all conventional fieldbus systems. In addition, we can supply you with modern peripherals such as a vision and conveyor tracking system.

## Make an appointment

Call us on  
**+49 2159 538 1800**

or send an email to  
**info.rs@epson.de**

Epson Deutschland GmbH  
Robotic Solutions Division  
Otto-Hahn-Straße 4  
40670 Meerbusch

Phone: **+49 2159 5381800**  
Fax: **+49 2159 5383170**  
E-Mail: **info.rs@epson.de**  
**www.epson.de/robots**

Epson America Inc.  
[www.epsonrobots.com](http://www.epsonrobots.com)

Seiko Epson Corp  
<http://global.epson.com/products/robots/>

Epson China Co, Ltd.  
[www.epson.com.cn/robots/](http://www.epson.com.cn/robots/)