

Installation projector range

Creative brilliance  
brought to life



**EPSON®**

# Excel in visual technology

Your success in the world of visual communications means having the freedom to project brighter, bolder, more creative images in every environment.

Our commitment to product quality, technology and relationships, backed by unparalleled service and support, is the reason we've been the world's No.1 projector manufacturer<sup>1</sup> since 2001. We never stop working on ways to give you the latest in quality, reliability and flexibility. From education and art galleries to digital signage and corporate events, from in-house projector fleets to the rental and staging market, our projectors are the smart, advanced solution.

## Exceptional image quality

We research, develop and manufacture every Epson projector to offer you outstanding image quality. Our comprehensive range of professional projector solutions offers a brightness range up to 30,000 lumens with 4K Enhancement and 4K Crystal Motion technology. This combination of ultra-high brightness and exceptional sharpness produces clear, vivid images that cut through high levels of ambient light, even at extreme display sizes.

## Cutting-edge technology

Our 3LCD technology is what sets us apart and it is at the heart of every Epson projector. This solid-state optical technology produces superb, true-to-life colours, up to three times brighter than conventional 1-chip DLP projectors<sup>2</sup>. Furthermore, our 3LCD optical engine does not produce a rainbow effect, so it is easier on the eye and looks just as perfect on camera.

## A wide range of lenses

Choose from extensive lens options with unparalleled compatibility across our range, each featuring motorised optics, memory function and excellent clarity for images up to 1,000 inches. Find the perfect solution for your installation environment with the same range of 4K quality lenses for projectors with 6,000 to 20,000 lumen brightness. Furthermore, our unique LX series of lenses offer ultra-short throw ratios with zero offset for projectors with brightness levels from 6,000 to 30,000 lumens.

## Ultimate projection versatility

Experience almost limitless installation flexibility with 360-degree installation and built-in warping and blending functionality. Bring floors, ceilings, curves, 3D objects and even buildings to life, creating immersive and engaging experiences anywhere and everywhere. Complex and multi-projector installations are made easy using the ELPEC01 camera and free Epson Projector Professional Tool (EPPT) software.

## Hassle-free maintenance and support

Our professional projectors are built to last, using advanced 5-in-1 laser light source technology offering up to 20,000 hours maintenance-free performance, and even longer in extended modes. Furthermore, with selected models having IP5X dust resistance, our products can withstand even the most demanding dusty environments. When you buy from Epson, you can rest assured you have our support from pre-sales technical assistance through to aftersales service from our expert team.

## Compact, efficient, precise

Three words that epitomise our approach to product development. This ethos has driven us to create the smallest and lightest 10,000 and 20,000 lumen 4K projectors in the world<sup>3</sup>. Combining these three values enables us to continue producing world-leading and market-beating products that meet the demands of our customers, whilst minimising their impact on the environment at every stage of their lifecycle.



# Showcase 4K excellence

Marvel at the clarity of the images produced by our latest 4K technology which is now available with the EB-PQ2000 Series\*. We have combined our patented, state of the art 4K Crystal Motion, panel thermo-control and double micro-lens array technologies to set the benchmark in 4K image quality.

Building on the highly compact and efficient EB-PU Series, we have incorporated a plethora of advanced new technologies to create the world's smallest and lightest 10,000 and 20,000 lumen 4K projectors<sup>3</sup>.



## Deeper blacks than ever before



Utilising the latest advancement in 3LCD panel technology, the native contrast of our 4K projectors is 1.5 times greater than preceding models. Black levels appear darker than ever before, contributing to a higher level of immersion in darker environments.

## Patented 4K Crystal Motion technology



In a world first, 3LCD and dual-axis shifting technologies have been combined to achieve a native 4K 3840 x 2160 on-screen pixel count with stunning clarity. The e-shift device operates with incredible precision to ensure maximum image sharpness. Combined with ultra-fast 240Hz frame processing, 4K video playback is smooth and supports up to 120Hz image input and output\*\*.

## Dynamic panel temperature control



Our panel thermo-control functionality provides direct, adaptive temperature control to each 3LCD panel to optimise the temperature for maximum image definition and brightness. The highly conductive vapour chamber is paired with a peltier element to quickly adapt to the optimum temperature.

## Maximum light efficiency

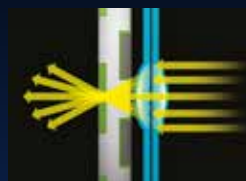

Featuring double micro-lens array technology, our range of 4K products are able to focus the light of each pixel to maximise light utilisation, resulting in a superior output resolution and sharpness.

## Custom-built graphic processing



Our newly designed graphic processing chip has been developed specifically to handle the demands of 4K image processing. This latest chipset provides significant improvements in operating frequency, memory bandwidth and data transmission for a seamless 4K experience.



\* Technologies used vary by projector model.  
\*\* 4K at 120Hz support will be added in 2024 by firmware update.

# Create unforgettable experiences for your audience

Stunning visual exhibits make memorable experiences that keep customers coming back for more.

Our most advanced projectors combine 3LCD and 4K Crystal Motion technology with vibrant colour and ultra-high contrast ratio to produce brilliant, true-to-life content reproduction, without any rainbow effect – perfect for that selfie moment.



The highly versatile EB-PQ2000 Series laser projectors provide a brightness range from 8,000 to 20,000 lumens and support a range of lens options so you can find the perfect solution. You can even add an external Epson camera to access advanced installation and calibration functionality.

The compact, yet powerful 10,000 lumen EB-PQ2010, achieves reliable performance while offering outstanding 4K image sharpness and vibrant brightness. This makes it perfect for a range of venues, including galleries, theme parks, digital art installations and many other visitor attractions.

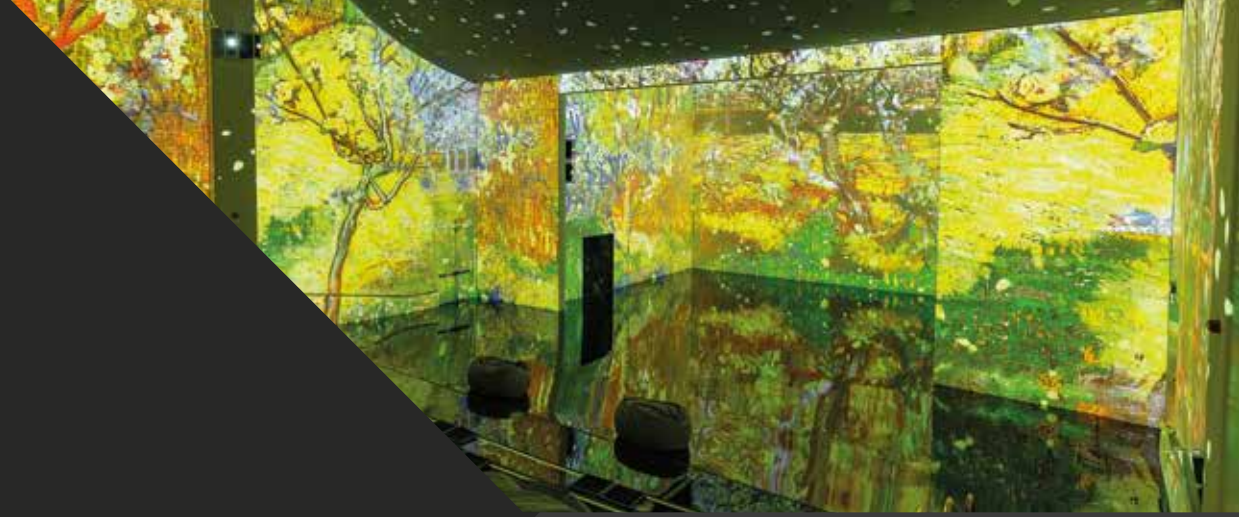

# Impress with the unexpected

It is no mystery that modern audiences demand to be amazed and delighted, and it is interactive immersive experiences that are driving visitors to some of the world's most famous arts and entertainment attractions. The secret to this success is projection technology which can transform spaces like no other technology.

## Transform any surface

Whatever surface type or shape, you can produce spectacular images by mapping onto 3D objects and spaces, giving you almost limitless opportunities for amazing creativity in immersive environments.

## Make a bigger impact

Delight audiences by projecting ultra-large, vivid and seamless displays. Perform edge blending and stacking with ease, using our built-in and PC-based features such as simple stacking, simple blending and camera assist for stacking and blending functionality.

## Deliver consistent images

Keep images consistent and minimise maintenance with the innovative camera solution for our laser projectors. It detects images that have become uneven or discoloured over time and recalibrates the image to ensure your impactful displays always look the way they were intended.



EB-PQ2010B

# Achieve the ultimate visual performance

There's more to a performance than what you see on stage. It's about allowing your audience to feel truly connected by experiencing the texture, sharpness, clarity and detail of stunning visual effects.

Our versatile, high-performance Pro AV projectors, led by the EB-L30000U, EB-PQ2220B and EB-PQ2010B, are designed for exceptional reliability and flexibility.

Meet the demands of audiences in theatres, auditoriums, concerts, large-scale corporate events and outdoor venues around the world.



EB-PQ2010B



EB-PQ2220B



EB-L30000U



# Illuminate bright ideas

## **Crystal-clear detail**

When you look for awe-inspiring visual experiences, you can rely on our meticulous research and development which has achieved many world-firsts in projection technology. Benefit from world-leading brightness and ensure pin-sharp, high definition images for large scale presentations and events with our innovative laser light source, 3LCD and 4K Crystal Motion technology.

## **Maximised fleet efficiency**

Our market leading compact and lightweight projectors present the perfect opportunity to maximise your fleet utilisation. Not only can you save on the costs of flight cases, storage and logistics but our simple stacking and blending functionality makes it easier than ever before to boost the brightness and projection size, while benefitting from built-in redundancy.

## **Simplified, easy maintenance**

Projectors used for rental and staging must be easy to maintain. Epson's EB-PQ2000 and EB-PU2200 Series feature a unique modular component design, improving access to internal parts and reducing the number of steps required for maintenance.

## **A 4K visual upgrade**

Our brand new range of 4K projectors, the EB-PQ2000 Series, features the world's smallest and lightest 10,000 and 20,000 lumen 4K projectors<sup>3</sup>, in the same revolutionary product platform as our existing EB-PU Series products. Introduce the latest advancement in 4K technology to your rental fleet and continue using your existing 4K-quality Epson lenses – no further investment required.

## **Unmatched durability**

Epson projectors are built to last with innovations in cooling and dust resistance leading to selected products with sophisticated liquid cooling systems to regulate the internal temperature, and a sealed optical engine and laser light source achieving an IP5X rating<sup>4</sup> and filter-free design. This results in a maintenance-free performance for up to 20,000 hours.



# Elevate your communication

## Captivate corporate audiences with large-format displays

We believe everyone in the room should be able to see the display clearly and our high brightness EB-PU Series is designed to make your content fully visible anywhere in the room with incredible brightness and clarity, even for the biggest of displays.

## Modernise your meeting spaces

Bring your meeting spaces up to date with our range of affordable projectors for medium and large meeting rooms, with up to 7,000 lumen brightness and up to 4KE resolution delivered by the EB-L700 Series.

Achieve high-quality, large screen presentations with the flexibility to project from a range of different sources, including wirelessly using built-in screen mirroring technology and our new ELPWP10 wireless presentation system. Replace legacy display solutions with ease thanks to wide manual lens shift and 4K input support.

## Surround your audience with the power of crystal clear 4K

Upgrade your display to the latest resolution on a large scale with our brand new 4K Crystal Motion technology, exclusive to our EB-PQ Series, which brings ultra-high definition image quality to your prestigious meeting and public display areas in a compact and discreet design.



EB-L770U



EB-PQ2008W



# Deliver more compelling presentations

## Create inspirational modern learning environments

Engage students with vibrant presentations using our higher education display solutions to deliver your content with the highest impact.

Our EB-PU1000 and EB-PU2200 Series laser projectors are designed for high brightness requirements with a range from 6,000 lumens to 20,000 lumens. Optional lenses with motorised optics provide installation flexibility, perfect when replacing and upgrading existing display solutions.

## Transform your presentations

Fully immerse your students in their subject using the future of experiential learning. 360-degree learning spaces are made possible using our zero-offset ultra-short throw lens, filling entire walls with pin-sharp, high-resolution content for a shared augmented reality experience.

## Prepare for the unexpected

Ensure your presentations are never interrupted, with our most advanced projectors featuring simple stacking for boosted brightness and built-in redundancy, and automatic signal switching to maintain the continuity of the input source.



## Connectivity

- 1 LAN port (RJ45: 100Base-TX)
- 2 HDBaseT port
- 3 DVI-D
- 4 HDMI input
- 5 HDMI output
- 6 3G-SDI input
- 7 Monitor output SDI
- 8 12G-SDI input
- 9 12G-SDI output
- 10 Computer input (Mini D-Sub 15-pin)
- 11 Monitor output (Mini D-Sub 15-pin)
- 12 Computer input / Monitor output (Mini D-Sub 15-pin)
- 13 BNC input (5BNC)
- 14 Service port
- 15 Remote port (stereo mini)
- 16 Audio in
- 17 Audio out
- 18 RS-232 port (Mini D-Sub 9-pin)
- 19 USB for optional wireless
- 20 USB for DC power out
- 21 USB Type-A
- 22 Near Field Communication (NFC)

### EB-PU1000 Series



Model shown is the EB-PU1008B

### EB-PU2010

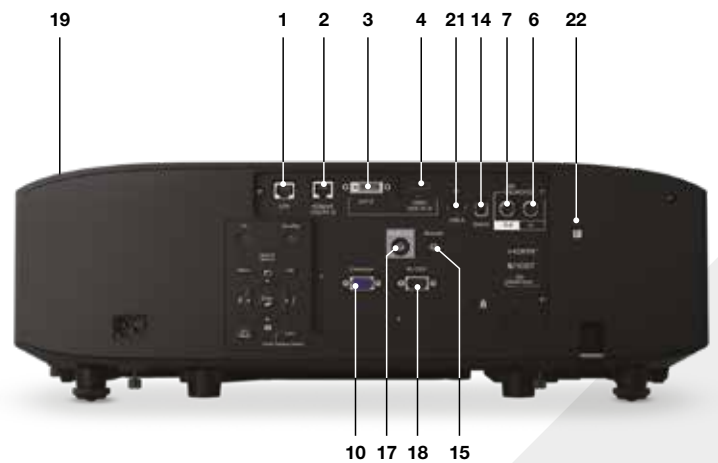

Model shown is the EB-PU2010B

### EB-PQ2008

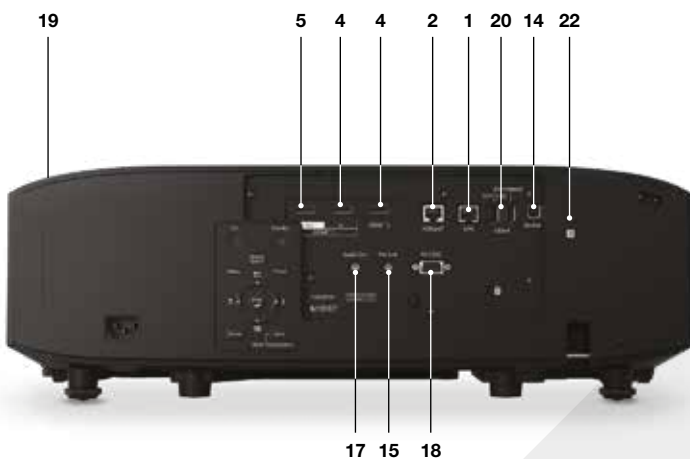

Model shown is the EB-PQ2008B

### EB-PQ2010



Model shown is the EB-PQ2010B

### EB-L700 Series

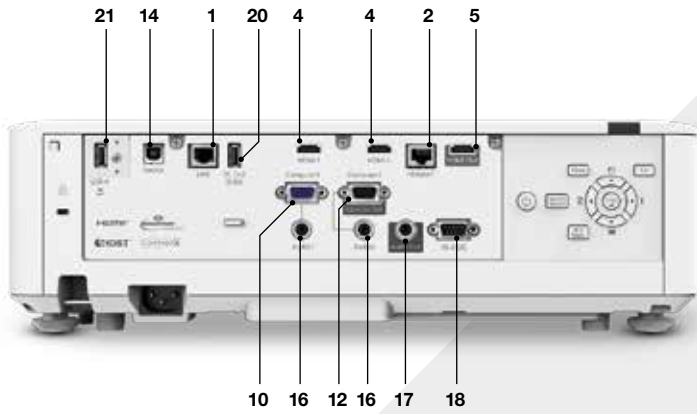

Model shown is the EB-L730U

### EB-L700 Series - 4KE models

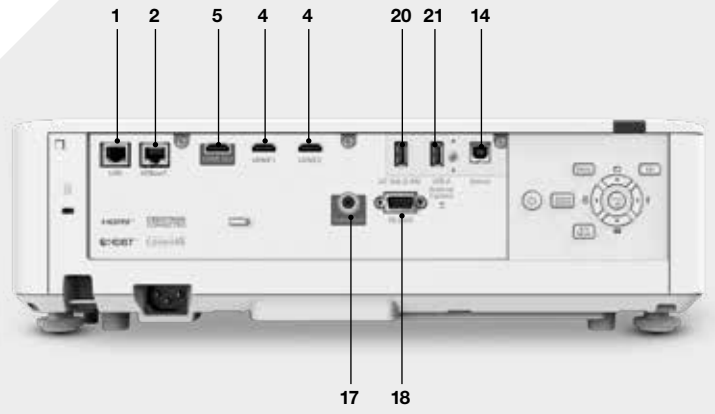

Model shown is the EB-L770U

### EB-PU2100 Series

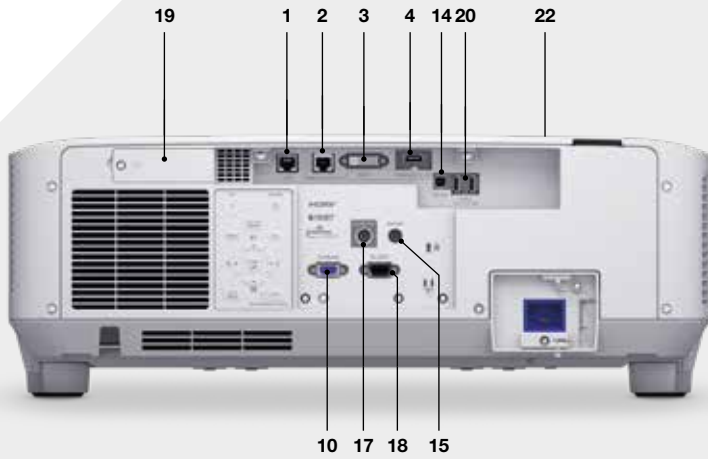

Model shown is the EB-PU2120W

### EB-PU2200 Series

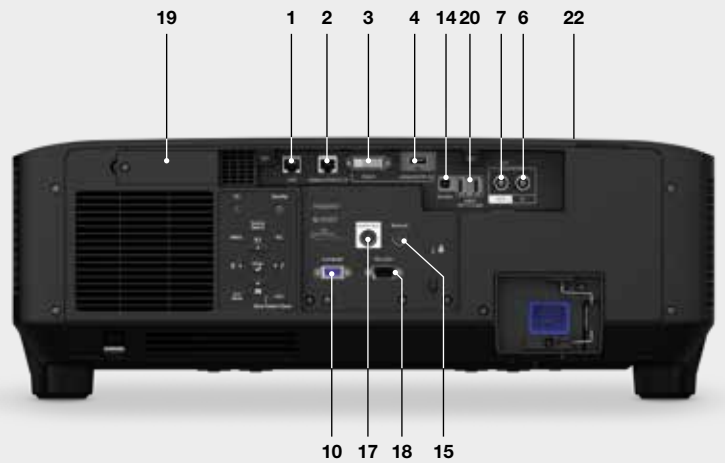

Model shown is the EB-PU2220B

### EB-PQ2200 Series

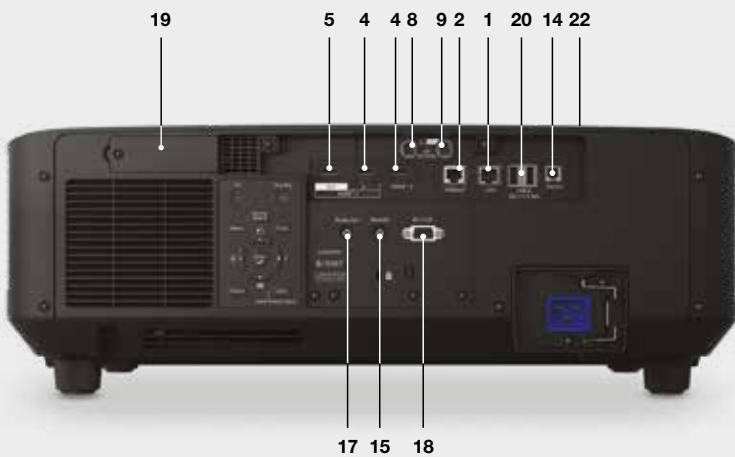





Model shown is the EB-PQ2220B



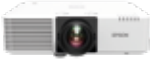

### EB-L30000U Series







Model shown is the EB-L30000U

Model	EB-L530U	EB-L570U	EB-L630U	EB-L630SU / EB-L635SU	EB-L730U / EB-L735U
					
Resolution	WUXGA (1920 x 1200)	4KE (WUXGA)	WUXGA (1920 x 1200)	WUXGA (1920 x 1200)	WUXGA (1920 x 1200)
Native aspect	16:10	16:10	16:10	16:10	16:10
Colour Light Output (lumens) normal / eco	5,200 / 3,640	5,200 / 3,640	6,200 / 4,340	6,000 / 4,200	7,000 / 4,900
Contrast ratio	Over 5,000,000:1	Over 5,000,000:1	Over 5,000,000:1	Over 5,000,000:1	Over 5,000,000:1
Lightsource	Laser	Laser	Laser	Laser	Laser
Lightsource life (hours) normal / eco	20,000 / 30,000	20,000 / 30,000	20,000 / 30,000	20,000 / 30,000	20,000 / 30,000
Throw ratio in native aspect	1.35 - 2.20:1	1.35 - 2.20:1	1.35 - 2.20:1	0.8:1	1.35 - 2.20:1
Scalable image size (diagonal)	50 - 500"	50 - 500"	50 - 500"	50 - 200"	50 - 500"
Zoom	Optical x1.6	Optical x1.6	Optical x1.6	Digital x1.35	Optical x1.6
Vertical keystone	Manual ±30°	Manual ±30°	Manual ±30°	Manual ±30°	Manual ±30°
Horizontal keystone	Manual ±30°	Manual ±30°	Manual ±30°	Manual ±30°	Manual ±30°
Lens shift	± 50% Vertical ± 20% Horizontal	± 50% Vertical ± 20% Horizontal	± 50% Vertical ± 20% Horizontal	± 50% Vertical ± 20% Horizontal	± 50% Vertical ± 20% Horizontal
Speaker output	10W	10W	10W	10W	10W
Connectivity	HDMI in x2, HDMI out, HDBaseT, VGA in x2, VGA out, RS-232C, USB Type A x2, USB Type B, Screen Mirroring (Miracast)	HDMI in x2, HDMI out, HDBaseT, RS-232C, USB Type A (2A), USB Type B	HDMI in x2, HDMI out, HDBaseT, VGA in x2, VGA out, RS-232C, USB Type A x2, USB Type B, Screen Mirroring (Miracast)	HDMI in x2, HDMI out, HDBaseT, VGA in x2, VGA out, RS-232C, USB Type A x2, USB Type B, Screen Mirroring (Miracast)	HDMI in x2, HDMI out, HDBaseT, VGA in x2, VGA out, RS-232C, USB Type A x2, USB Type B, Screen Mirroring (Miracast)
Audio connectivity	Stereo mini in x2, Stereo mini out	Stereo mini out	Stereo mini in x2, Stereo mini out	Stereo mini in x2, Stereo mini out	Stereo mini in x2, Stereo mini out
Networking	LAN (RJ45), built-in wireless LAN unit	LAN (RJ45), optional wireless LAN unit	LAN (RJ45), built-in wireless LAN unit	LAN (RJ45), built-in wireless LAN unit	LAN (RJ45), built-in wireless LAN unit
Epson software solutions	Epson iProjection (Windows/Mac), Epson iProjection App for iOS, Android and Chromebook, Epson Projector Professional Tool, Epson Projector Management, Epson Projector Content Manager, Epson Creative Projection	Epson Projector Management (Windows), Epson iProjection (Windows/Mac/iOS/Android/Chrome), Epson Projector Professional Tool (Windows/ Mac), Epson Projector Content Manager (Windows/Mac), Epson Creative Projection (iOS)	Epson iProjection (Windows/Mac), Epson iProjection App for iOS, Android and Chromebook, Epson Projector Professional Tool, Epson Projector Management, Epson Projector Content Manager, Epson Creative Projection	Epson iProjection (Windows/Mac), Epson iProjection App for iOS, Android and Chromebook, Epson Projector Professional Tool, Epson Projector Management, Epson Projector Content Manager, Epson Creative Projection	Epson iProjection (Windows/Mac), Epson iProjection App for iOS, Android and Chromebook, Epson Projector Professional Tool, Epson Projector Management, Epson Projector Content Manager, Epson Creative Projection
Other features	A/V mute, USB content playback for source-free signage, Edge blending, Daisy chain multi-projection, Point and Arc correction, Schedule function, Split screen, Auto source search, Copy OSD settings, Padlock, Security cable hole, Kensington lock, 360° installation, Cable cover included	4K enhancement, A/V mute, Edge blending, Point correction, Quick Corner, Curved surface correction, Corner wall, Geometry correction memory, Schedule setting, Split screen, Source search, Padlock & Security Cable Hole, Kensington Lock, Wireless LAN Unit Lock, PC Free (Still image/ Movie), Copy OSD settings, Projector Control and Management, 360° installation, Cable cover included, Optional camera	A/V mute, USB content playback for source-free signage, Edge blending, Daisy chain multi-projection, Point and Arc correction, Schedule function, Split screen, Auto source search, Copy OSD settings, Padlock, Security cable hole, Kensington lock, 360° installation, Cable cover included	A/V mute, USB content playback for source-free signage, Edge blending, Daisy chain multi-projection, Point and Arc correction, Schedule function, Split screen, Auto source search, Copy OSD settings, Padlock, Security cable hole, Kensington lock, 360° installation, Cable cover included	A/V mute, USB content playback for source-free signage, Edge blending, Daisy chain multi-projection, Point and Arc correction, Schedule function, Split screen, Auto source search, Copy OSD settings, Padlock, Security cable hole, Kensington lock, 360° installation, Cable cover included
Noise (dB) normal / eco	31 / 23	31 / 23	38 / 27	38 / 27	38 / 27
Weight (kg)	8.2	8.3	8.4	8.4	8.4
Dimensions exc. feet (W x D x H mm)	440 x 304 x 122	440 x 304 x 122	440 x 304 x 122	440 x 304 x 122	440 x 304 x 122
Power consumption normal / eco	293W / 223W	312W / 234W	345W / 258W	345W / 258W	345W / 258W
Power consumption standby, comm. off	0.3W	0.5W	0.3W	0.3W	0.3W
Standard interchangeable lens included	N/A	N/A	N/A	N/A	N/A
Warranty	3 years	3 years	3 years	3 years	3 years







Model	EB-L770U / EB-L775U	EB-PU1006W	EB-PU1007W/B	EB-PU1008W/B	EB-PU2010W/B
					
Resolution	4KE (WUXGA)	WUXGA (1920 x 1200)	WUXGA (1920 x 1200)	WUXGA (1920 x 1200)	WUXGA (1920 x 1200)
Native aspect	16:10	16:10	16:10	16:10	16:10
Colour Light Output (lumens) normal / eco	7,000 / 4,900	6,000 / 4,200	7,000 / 4,900	8,500 / 5,950	10,000 / 7,000
Contrast ratio	Over 5,000,000:1	Over 5,000,000:1	Over 5,000,000:1	Over 5,000,000:1	Over 5,000,000:1
Lightsource	Laser	Laser	Laser	Laser	Laser
Lightsource life (hours) normal / eco	20,000 / 30,000	20,000 / 30,000	20,000 / 30,000	20,000 / 30,000	20,000 / 30,000
Throw ratio in native aspect	1.35 - 2.20:1	1.44 - 2.32:1	1.44 - 2.32:1	1.44 - 2.32:1	1.57 - 2.56:1
Scalable image size (diagonal)	50 - 500"	50 - 1,000"	50 - 1,000"	50 - 1,000"	60 - 1,000"
Zoom	Optical x1.6	Optical x1.6	Optical x1.6	Optical x1.6	Optical x1.6
Vertical keystone	Manual ±30°	Manual ±45°	Manual ±45°	Manual ±45°	Manual ±45°
Horizontal keystone	Manual ±30°	Manual ±30°	Manual ±30°	Manual ±30°	Manual ±30°
Lens shift	± 50% Vertical ± 20% Horizontal	± 67% Vertical ± 30% Horizontal	± 67% Vertical ± 30% Horizontal	± 67% Vertical ± 30% Horizontal	± 60% Vertical ± 18% Horizontal
Speaker output	10W	N/A	N/A	N/A	N/A
Connectivity	HDMI in x2, HDMI out, HDBaseT, RS-232C, USB Type A (2A), USB Type B	HDMI in (HDCP 2.3), DVI in, HDBaseT, VGA in, RS-232C, USB Type A, USB Type B (Service only), Remote, NFC	HDMI in (HDCP 2.3), DVI in, HDBaseT, VGA in, RS-232C, USB Type A, USB Type B (Service only), Remote, NFC	HDMI in (HDCP 2.3), DVI in, HDBaseT, VGA in, RS-232C, USB Type A, USB Type B (Service only), Remote, NFC	HDMI in (HDCP 2.3), DVI in, HDBaseT, SDI in, SDI out, VGA in, RS-232C, USB Type A, USB Type B (Service only), Remote, NFC
Audio connectivity	Stereo mini out	Stereo mini out	Stereo mini out	Stereo mini out	Stereo mini out
Networking	LAN (RJ45), optional wireless LAN unit	LAN (RJ45) and optional wireless LAN unit	LAN (RJ45) and optional wireless LAN unit	LAN (RJ45) and optional wireless LAN unit	LAN (RJ45) and optional wireless LAN unit
Epson software solutions	Epson Projector Management (Windows), Epson iProjection (Windows/Mac/iOS/Android/Chrome), Epson Projector Professional Tool (Windows/ Mac), Epson Projector Content Manager (Windows/Mac), Epson Creative Projection (iOS)	Epson iProjection (Windows/Mac), Epson iProjection App for iOS, Android and Chromebook, Epson Projector Professional Tool, Epson Projector Management, Epson Projector Content Manager, Epson Creative Projection, Epson Projector Config Tool	Epson iProjection (Windows/Mac), Epson iProjection App for iOS, Android and Chromebook, Epson Projector Professional Tool, Epson Projector Management, Epson Projector Content Manager, Epson Creative Projection, Epson Projector Config Tool	Epson iProjection (Windows/Mac), Epson iProjection App for iOS, Android and Chromebook, Epson Projector Professional Tool, Epson Projector Management, Epson Projector Content Manager, Epson Creative Projection, Epson Projector Config Tool	Epson iProjection (Windows/Mac), Epson iProjection App for iOS, Android and Chromebook, Epson Projector Professional Tool, Epson Projector Management, Epson Projector Content Manager, Epson Creative Projection, Epson Projector Config Tool
Other features	4K enhancement, A/V mute, Edge blending, Point correction, Quick Corner, Curved surface correction, Corner wall, Geometry correction memory, Schedule setting, Split screen, Source search, Padlock & Security Cable Hole, Kensington Lock, Wireless LAN Unit Lock, PC Free (Still image/ Movie), Copy OSD settings, Projector Control and Management, 360° installation, Cable cover included, Optional camera	4K enhancement, HDR support, Powered zoom, Focus and lens shift, Lens memory, Interchangeable lens options including zero offset UST lens, Optional camera, Portrait projection, 21:9 display, A/V mute, USB content playback for source-free signage, Edge blending, Point correction, Curved surface and corner wall correction, 360° installation	4K enhancement, HDR support, Powered zoom, Focus and lens shift, Lens memory, Interchangeable lens options including zero offset UST lens, Optional camera, Portrait projection, 21:9 display, A/V mute, USB content playback for source-free signage, Edge blending, Point correction, Curved surface and corner wall correction, 360° installation	4K enhancement, HDR support, Powered zoom, Focus and lens shift, Lens memory, Interchangeable lens options including zero offset UST lens, Optional camera, Portrait projection, 21:9 display, A/V mute, USB content playback for source-free signage, Edge blending, Point correction, Curved surface and corner wall correction, 360° installation	4K enhancement, HDR support, Powered zoom, Focus and lens shift, Lens memory, Interchangeable lens options including zero offset UST lens, Optional camera, Daisy chain multi-projection, Portrait projection, 21:9 display, A/V mute, USB content playback for source-free signage, Edge blending, Point correction, Curved surface and corner wall correction, 360° installation
Noise (dB) normal / eco	38 / 27	30 / 28	33 / 29	35 / 30	37 / 30
Weight (kg)	8.5	15.4	16.3	16.3	16.8
Dimensions exc. feet (W x D x H mm)	440 x 304 x 122	545 x 436 x 164	545 x 436 x 164	545 x 436 x 164	545 x 436 x 164
Power consumption normal / eco	366W / 268W	367W / 310W	431W / 366W	535W / 452W	535W / 452W
Power consumption standby, comm. off	0.5W	0.5W	0.5W	0.5W	0.5W
Standard interchangeable lens included	N/A	No	No	No	No
Warranty	3 years	3 years	3 years	3 years	3 years

Specifications vary by lens, please refer to lens specifications.





Model	EB-PU2113W	EB-PU2213B	EB-PU2116W	EB-PU2216B
				
Resolution	WUXGA (1920 x 1200)	WUXGA (1920 x 1200)	WUXGA (1920 x 1200)	WUXGA (1920 x 1200)
Native aspect	16:10	16:10	16:10	16:10
Colour Light Output (lumens) normal / eco	13,000 / 9,100	13,000 / 9,100	16,000 / 11,200	16,000 / 11,200
Contrast ratio	Over 5,000,000:1	Over 5,000,000:1	Over 5,000,000:1	Over 5,000,000:1
Lightsource	Laser	Laser	Laser	Laser
Lightsource life (hours) normal / eco	20,000 / 30,000	20,000 / 30,000	20,000 / 30,000	20,000 / 30,000
Throw ratio in native aspect	1.57 - 2.56:1	1.57 - 2.56:1	1.57 - 2.56:1	1.57 - 2.56:1
Scalable image size (diagonal)	60 - 1,000"	60 - 1,000"	60 - 1,000"	60 - 1,000"
Zoom	Optical x1.6	Optical x1.6	Optical x1.6	Optical x1.6
Vertical keystone Horizontal keystone	Manual ±45° Manual ±30°	Manual ±45° Manual ±30°	Manual ±45° Manual ±30°	Manual ±45° Manual ±30°
Lens shift	± 60% Vertical ± 18% Horizontal	± 60% Vertical ± 18% Horizontal	± 60% Vertical ± 18% Horizontal	± 60% Vertical ± 18% Horizontal
Speaker output	N/A	N/A	N/A	N/A
Connectivity	HDMI in (HDCP 2.3), DVI in, HDBaseT, VGA in, RS-232C, USB Type A x2, USB Type B (Service only), Remote, NFC	HDMI in (HDCP 2.3), DVI in, HDBaseT, SDI in, SDI out, VGA in, RS-232C, USB Type A x2, USB Type B (Service only), Remote, NFC	HDMI in (HDCP 2.3), DVI in, HDBaseT, VGA in, RS-232C, USB Type A x2, USB Type B (Service only), Remote, NFC	HDMI in (HDCP 2.3), DVI in, HDBaseT, SDI in, SDI out, VGA in, RS-232C, USB Type A x2, USB Type B (Service only), Remote, NFC
Audio connectivity	Stereo mini out	Stereo mini out	Stereo mini out	Stereo mini out
Networking	LAN (RJ45) and optional wireless LAN unit	LAN (RJ45) and optional wireless LAN unit	LAN (RJ45) and optional wireless LAN unit	LAN (RJ45) and optional wireless LAN unit
Epson software solutions	Epson iProjection (Windows/Mac), Epson iProjection App for iOS, Android and Chromebook, Epson Projector Professional Tool, Epson Projector Management, Epson Projector Content Manager, Epson Creative Projection, Epson Projector Config Tool	Epson iProjection (Windows/Mac), Epson iProjection App for iOS, Android and Chromebook, Epson Projector Professional Tool, Epson Projector Management, Epson Projector Content Manager, Epson Creative Projection, Epson Projector Config Tool	Epson iProjection (Windows/Mac), Epson iProjection App for iOS, Android and Chromebook, Epson Projector Professional Tool, Epson Projector Management, Epson Projector Content Manager, Epson Creative Projection, Epson Projector Config Tool	Epson iProjection (Windows/Mac), Epson iProjection App for iOS, Android and Chromebook, Epson Projector Professional Tool, Epson Projector Management, Epson Projector Content Manager, Epson Creative Projection, Epson Projector Config Tool
Other features	4K enhancement, HDR support, Powered zoom, Focus and lens shift, Lens memory, Interchangeable lens options including zero offset UST lens, Optional camera, Portrait projection, 21:9 display, A/V mute, USB content playback for source-free signage, Edge blending, Point correction, Curved surface and corner wall correction, 360° installation, IP5X certified**	4K enhancement, HDR support, Powered zoom, Focus and lens shift, Lens memory, Interchangeable lens options including zero offset UST lens, Optional camera, Daisy chain multi-projection, Mechanical shutter, Portrait projection, 21:9 display, A/V mute, USB content playback for source-free signage, Edge blending, Point correction, Curved surface and corner wall correction, 360° installation, IP5X certified**	4K enhancement, HDR support, Powered zoom, Focus and lens shift, Lens memory, Interchangeable lens options including zero offset UST lens, Optional camera, Portrait projection, 21:9 display, A/V mute, USB content playback for source-free signage, Edge blending, Point correction, Curved surface and corner wall correction, 360° installation, IP5X certified**	4K enhancement, HDR support, Powered zoom, Focus and lens shift, Lens memory, Interchangeable lens options including zero offset UST lens, Optional camera, Daisy chain multi-projection, Mechanical shutter, Portrait projection, 21:9 display, A/V mute, USB content playback for source-free signage, Edge blending, Point correction, Curved surface and corner wall correction, 360° installation, IP5X certified**
Noise (dB) normal / eco	34 / 29	34 / 29	38 / 34	38 / 34
Weight (kg)	23.8	23.7	24.3	24.2
Dimensions exc. feet (W x D x H mm)	586 x 492 x 185	586 x 492 x 185	586 x 492 x 185	586 x 492 x 185
Power consumption normal / eco	864W / 633W	864W / 633W	1083W / 773W	1083W / 773W
Power consumption standby, comm. off	0.5W	0.5W	0.5W	0.5W
Standard interchangeable lens included	No	No	No	No
Warranty	3 years	3 years	3 years	3 years

\*\* IP5X certified in accordance with IEC Standard 60529. The IP5X certification is applied to the optical engine and light source module. Specifications vary by lens, please refer to lens specifications.

Model	EB-PU2120W	EB-PU2220B	EB-L30000U	EB-PQ2008W/B
				
Resolution	WUXGA (1920 x 1200)	WUXGA (1920 x 1200)	WUXGA (1920 x 1200)	4K (3840 x 2160)*
Native aspect	16:10	16:10	16:10	16:9
Colour Light Output (lumens) normal / eco	20,000 / 14,000	20,000 / 14,000	30,000 / 21,000	8,000 / 5,600
Contrast ratio	Over 5,000,000:1	Over 5,000,000:1	Over 5,000,000:1	Over 5,000,000:1
Lightsources	Laser	Laser	Laser	Laser
Lightsources life (hours) normal / eco	20,000 / 30,000	20,000 / 30,000	20,000 / 30,000	20,000 / 30,000
Throw ratio in native aspect	1.57 - 2.56:1	1.57 - 2.56:1	1.74 - 2.35:1	1.52 - 2.47:1
Scalable image size (diagonal)	60 - 1,000"	60 - 1,000"	100 - 1,000"	60 - 1,000"
Zoom	Optical x1.6	Optical x1.6	Optical x1.4	Optical x1.6
Vertical keystone	Manual ±45°	Manual ±45°	Manual ±45°	Manual ±45°
Horizontal keystone	Manual ±30°	Manual ±30°	Manual ±30°	Manual ±30°
Lens shift	± 60% Vertical ± 18% Horizontal	± 60% Vertical ± 18% Horizontal	± 65% Vertical ± 30% Horizontal	± 58% Vertical ± 16% Horizontal
Speaker output	N/A	N/A	N/A	N/A
Connectivity	HDMI in (HDCP 2.3), DVI in, HDBaseT, VGA in, RS-232C, USB Type A x2, USB Type B (Service only), Remote, NFC	HDMI in (HDCP 2.3), DVI in, HDBaseT, SDI in, SDI out, VGA in, RS-232C, USB Type A x2, USB Type B (Service only), Remote, NFC	VGA in, VGA out, DVI in, BNC in, HDBaseT, HD-SDI, HDMI (HDCP 2.2)	HDMI in x2, HDMI out, HDBaseT, RS-232C, USB Type A x2, USB Type B (Service only), Remote, NFC
Audio connectivity	Stereo mini out	Stereo mini out	N/A	Stereo mini out
Networking	LAN (RJ45) and optional wireless LAN unit	LAN (RJ45) and optional wireless LAN unit	LAN (RJ45) and optional wireless LAN unit	LAN (RJ45) and optional wireless LAN unit
Epson software solutions	Epson iProjection (Windows/Mac), Epson iProjection App for iOS, Android and Chromebook, Epson Projector Professional Tool, Epson Projector Management, Epson Projector Content Manager, Epson Creative Projection, Epson Projector Config Tool	Epson iProjection (Windows/Mac), Epson iProjection App for iOS, Android and Chromebook, Epson Projector Professional Tool, Epson Projector Management, Epson Projector Content Manager, Epson Creative Projection, Epson Projector Config Tool	Epson Projector Management, Epson iProjection (Windows/Mac), Epson iProjection App for iOS and Android, Epson Projector Professional Tool	Epson iProjection (Windows/Mac), Epson iProjection App for iOS, Android and Chromebook, Epson Projector Professional Tool, Epson Projector Management, Epson Projector Content Manager, Epson Creative Projection, Epson Projector Config Tool
Other features	4K enhancement, HDR support, Powered zoom, Focus and lens shift, Lens memory, Interchangeable lens options including zero offset UST lens, Optional camera, Portrait projection, 21:9 display, A/V mute, USB content playback for source-free signage, Edge blending, Point correction, Curved surface and corner wall correction, 360° installation, IP5X certified**	4K enhancement, HDR support, Powered zoom, Focus and lens shift, Lens memory, Interchangeable lens options including zero offset UST lens, Optional camera, Daisy chain multi-projection, Portrait projection, Mechanical shutter, 21:9 display, A/V mute, USB content playback for source-free signage, Edge blending, Point correction, Curved surface and corner wall correction, 360° installation, IP5X certified**	Fully sealed optical system, Interchangeable lens options, Powered zoom, Focus and lens shift, Lens memory, Integrated camera for colour calibration, 4K enhancement, 360° installation, Edge blending, Portrait projection, Epson Projector Professional Tool. Also available in white (EB-L30002U)	4K Crystal Motion, HDR support, Powered zoom, focus and lens shift, Lens memory, Interchangeable lens options including zero offset UST lens, Optional camera, Daisy chain multi-projection, Portrait projection, 21:9 display, A/V mute, USB content playback for source-free signage, Edge blending, Point correction, Curved surface and corner wall correction, 360° installation, Back up source function, 120Hz support
Noise (dB) normal / eco	45 / 37	45 / 37	49 / 41	35 / 29
Weight (kg)	24.4	24.4	63.8	18.6
Dimensions exc. feet (W x D x H mm)	586 x 492 x 185	586 x 492 x 185	790 x 710 x 299	545 x 436 x 164
Power consumption normal / eco	1301W / 899W	1301W / 899W	2,325W / 1,511W	502W / 410W
Power consumption standby, comm. off	0.5W	0.5W	0.5W	0.5W
Standard interchangeable lens included	No	No	No	No
Warranty	3 years	3 years	5 years / 20,000hrs	3 years

\* Maximum physical resolution using 4K Crystal Motion technology.

\*\* IP5X certified in accordance with IEC Standard 60529. The IP5X certification is applied to the optical engine and light source module. Specifications vary by lens, please refer to lens specifications. **EB-PQ model specifications are preliminary and subject to change.**

Model	EB-PQ2010W/B	EB-PQ2213B	EB-PQ2216W/B	EB-PQ2220B
				
Resolution	4K (3840 x 2160)*	4K (3840 x 2160)*	4K (3840 x 2160)*	4K (3840 x 2160)*
Native aspect	16:9	16:9	16:9	16:9
Colour Light Output (lumens) normal / eco	10,000 / 7,000	13,000 / 9,100	16,000 / 11,200	20,000 / 14,000
Contrast ratio	Over 5,000,000:1	Over 5,000,000:1	Over 5,000,000:1	Over 5,000,000:1
Lightsource	Laser	Laser	Laser	Laser
Lightsource life (hours) normal / eco	20,000 / 30,000	20,000 / 30,000	20,000 / 30,000	20,000 / 30,000
Throw ratio in native aspect	1.52 - 2.47:1	1.52 - 2.47:1	1.52 - 2.47:1	1.52 - 2.47:1
Scalable image size (diagonal)	60 - 1,000"	60 - 1,000"	60 - 1,000"	60 - 1,000"
Zoom	Optical x1.6	Optical x1.6	Optical x1.6	Optical x1.6
Vertical keystone Horizontal keystone	Manual $\pm 45^\circ$ Manual $\pm 30^\circ$	Manual $\pm 45^\circ$ Manual $\pm 30^\circ$	Manual $\pm 45^\circ$ Manual $\pm 30^\circ$	Manual $\pm 45^\circ$ Manual $\pm 30^\circ$
Lens shift	$\pm 58\%$ Vertical $\pm 16\%$ Horizontal	$\pm 58\%$ Vertical $\pm 16\%$ Horizontal	$\pm 58\%$ Vertical $\pm 16\%$ Horizontal	$\pm 58\%$ Vertical $\pm 16\%$ Horizontal
Speaker output	N/A	N/A	N/A	N/A
Connectivity	HDMI in x2, HDMI out, 12G-SDI in, 12G-SDI out, HDBaseT, RS-232C, USB Type A x2, USB Type B (Service only), Remote, NFC	HDMI in x2, HDMI out, 12G-SDI in, 12G-SDI out, HDBaseT, RS-232C, USB Type A x2, USB Type B (Service only), Remote, NFC	HDMI in x2, HDMI out, 12G-SDI in, 12G-SDI out, HDBaseT, RS-232C, USB Type A x2, USB Type B (Service only), Remote, NFC	HDMI in x2, HDMI out, 12G-SDI in, 12G-SDI out, HDBaseT, RS-232C, USB Type A x2, USB Type B (Service only), Remote, NFC
Audio connectivity	Stereo mini out	Stereo mini out	Stereo mini out	Stereo mini out
Networking	LAN (RJ45) and optional wireless LAN unit	LAN (RJ45) and optional wireless LAN unit	LAN (RJ45) and optional wireless LAN unit	LAN (RJ45) and optional wireless LAN unit
Epson software solutions	Epson iProjection (Windows/Mac), Epson iProjection App for iOS, Android and Chromebook, Epson Projector Professional Tool, Epson Projector Management, Epson Projector Content Manager, Epson Creative Projection, Epson Projector Config Tool	Epson iProjection (Windows/Mac), Epson iProjection App for iOS, Android and Chromebook, Epson Projector Professional Tool, Epson Projector Management, Epson Projector Content Manager, Epson Creative Projection, Epson Projector Config Tool	Epson iProjection (Windows/Mac), Epson iProjection App for iOS, Android and Chromebook, Epson Projector Professional Tool, Epson Projector Management, Epson Projector Content Manager, Epson Creative Projection, Epson Projector Config Tool	Epson iProjection (Windows/Mac), Epson iProjection App for iOS, Android and Chromebook, Epson Projector Professional Tool, Epson Projector Management, Epson Projector Content Manager, Epson Creative Projection, Epson Projector Config Tool
Other features	4K Crystal Motion, HDR support, Powered zoom, focus and lens shift, Lens memory, Interchangeable lens options including zero offset UST lens, Optional camera, Daisy chain multi-projection, Portrait projection, 21:9 display, A/V mute, USB content playback for source-free signage, Edge blending, Point correction, Curved surface and corner wall correction, 360° installation, Back up source function, 120Hz support	4K Crystal Motion, HDR support, Powered zoom, focus and lens shift, Lens memory, Interchangeable lens options including zero offset UST lens, Optional camera, Daisy chain multi-projection, Portrait projection, Mechanical shutter, 21:9 display, A/V mute, USB content playback for source-free signage, Edge blending, Point correction, Curved surface and corner wall correction, 360° installation, IP5X certified**, Back up source function, 120Hz support	4K Crystal Motion, HDR support, Powered zoom, focus and lens shift, Lens memory, Interchangeable lens options including zero offset UST lens, Optional camera, Daisy chain multi-projection, Portrait projection, Mechanical shutter, 21:9 display, A/V mute, USB content playback for source-free signage, Edge blending, Point correction, Curved surface and corner wall correction, 360° installation, IP5X certified**, Back up source function, 120Hz support	4K Crystal Motion, HDR support, Powered zoom, focus and lens shift, Lens memory, Interchangeable lens options including zero offset UST lens, Optional camera, Daisy chain multi-projection, Portrait projection, Mechanical shutter, 21:9 display, A/V mute, USB content playback for source-free signage, Edge blending, Point correction, Curved surface and corner wall correction, 360° installation, IP5X certified**, Back up source function, 120Hz support
Noise (dB) normal / eco	39 / 29	37 / 34	44 / 36	48 / 39
Weight (kg)	18.8	28.8	29.2	29.2
Dimensions exc. feet (W x D x H mm)	545 x 436 x 164	586 x 492 x 185	586 x 492 x 185	586 x 492 x 185
Power consumption normal / eco	613W / 483W	925W / 666W	1114W / 784W	1431W / 975W
Power consumption standby, comm. off	0.5W	0.5W	0.5W	0.5W
Standard interchangeable lens included	No	No	No	No
Warranty	3 years	3 years	3 years	3 years

\* Maximum physical resolution using 4K Crystal Motion technology.

\*\* IP5X certified in accordance with IEC Standard 60529. The IP5X certification is applied to the optical engine and light source module. Specifications vary by lens, please refer to lens specifications. **EB-PQ model specifications are preliminary and subject to change.**





# Unlock the full potential of your projector

Our professional software allows you to harness the full capabilities of your Epson projectors. Our range of free-to-download software provides powerful tools for projector installations, maintenance and content management.

## **Precise projection**

Effortlessly stack and blend multiple projectors for ultra-bright or expansive displays. Use the Epson ELPEC01 camera for seamless dual-projector stack and blends—no PC required. For larger setups or curved screens, rely on the free Epson Projector Professional Tool (EPPT), supporting up to 15 projectors with advanced functionality.

## **Efficient monitoring and control**

Manage your projector fleet with ease. Monitor and control basic functions remotely, including power, source and image positioning. Embrace Epson Projector Management Connected (EPMC), our cloud-based solution for remote access from anywhere.

## **Streamlined configuration with NFC**

Setting up a large fleet is simplified with Near Field Communication (NFC) and the Epson Projector Configuration Tool (EPCT) app. Register and edit settings on your smartphone, then effortlessly upload to the entire fleet without powering on projectors.

## **Seamless colour control**

Achieve seamless colour and brightness matching, calibration and uniformity adjustments with Epson's cutting-edge camera solution.

## **An elevated content experience**

Fuel creativity with the Epson Creative Projection app. Manage custom content and play it directly from SD cards or USB dongles using Epson Projector Content Manager Software.



# Unparalleled lens compatibility

When it comes to projector lenses, Epson has a unique offering.

## Large image sizes

Choose from a range of lenses covering image sizes up to 1000" with stunning clarity. Whether it's a conventional meeting space, immersive room or an entire building, rest assured we have the lens for you.

## Flexible positioning

Whether it is front or rear projection, our comprehensive lens line-up features fully motorised optics supporting zoom, focus, lens shift and even distortion adjustment on selected models. Furthermore, with up to 10 lens memory slots, you can save and reload image position presets with amazing precision.

## Compatibility

We have a single line-up of lenses covering all our interchangeable lens models from 6,000 lumens to 20,000 lumens. This unrivalled compatibility has made Epson the smart choice for rental fleets and fixed installation projects.

## 4K quality

Not all lenses are created equally but our range of lenses support true 4K output, producing outstanding image sharpness, regardless of the projector resolution or image size.

## Ultra-short throw

Our LX Series lenses are ideal for narrow spaces and rear-projection applications. Featuring a wide lens shift range and zero-offset design, these lenses provide the flexibility to transform even the most compact spaces. Available in black or white.



## Optional lens specifications

Customise your installation projector with Epson's optional powered lenses. Available in a range of throw ratios to suit different venues, screen sizes and projector distances, create the best possible image quality and match your budget.

### EB-L30000U

Lens type	Ultra-short-throw	Rear projection	Short throw	Wide throw	Mid throw	Mid throw	Mid throw	Long throw	Long throw
Model name	ELPLX03	ELPLR05	ELPLU05	ELPLW07	ELPLM12	ELPLM13	ELPLM14	ELPLL09	ELPLL10
Lens option									
Part code	V12H004X03	V12H004R05	V12H004U05	V12H004W07	V12H004M0C	V12H004M0D	V12H004M0E	V12H004L09	V12H004L0A
Zoom ratio	–	–	1 – 1.21	1 – 1.37	1 – 1.35	1 – 1.52	1 – 1.50	1 – 1.50	1 – 1.50
Throw ratio	0.35:1	0.60:1	0.90 – 1.09:1	1.29 – 1.76:1	1.74 – 2.35:1	2.28 – 3.46:1	3.41 – 5.12:1	4.79 – 7.20:1	6.96 – 10.45:1
Screen size range	120 – 1000" (0.89 – 7.71m)	100 – 1,000" (2.54 – 25.4 m)	100 – 1,000" (2.54 – 25.4 m)	100 – 1,000" (2.54 – 25.4 m)	100 – 1,000" (2.54 – 25.4 m)	100 – 1,000" (2.54 – 25.4 m)	100 – 1,000" (2.54 – 25.4 m)	100 – 1,000" (2.54 – 25.4 m)	100 – 1,000" (2.54 – 25.4 m)
Lens shift	V: ±25 % H: ±15 %	V: ±15 % H: ±5 %	V: ±55 % H: ±25 %	V: ±65 % H: ±30 %	V: ±65 % H: ±30 %	V: ±65 % H: ±30 %	V: ±65 % H: ±30 %	V: ±55 % H: ±25 %	V: ±55 % H: ±25 %

### EB-PU and EB-PQ Series

Lens type	Ultra-short-throw				Short throw	Short throw	Wide throw
Model name	ELPLX01S*	ELPLX01WS*	ELPLX02S**	ELPLX02WS**	ELPLU03S	ELPLU04	ELPLW05***
Lens option							
Part code	V12H004X0A	V12H004Y0A	V12H004X0B	V12H004Y0B	V12H004UA3	V12H004U04	V12H004W05
Diagonal image size	100 – 1,000" (2.54 – 25.4 m)	100 – 1,000" (2.54 – 25.4 m)	100 – 1,000" (2.54 – 25.4 m)	100 – 1,000" (2.54 – 25.4 m)	80 – 1,000" (2 – 25.4 m)	50 – 1,000" (1.27 – 25.4 m)	50 – 1,000" (1.27 – 25.4 m)
EB-PU1000 Series	Throw ratio Lens shift	WUXGA 16:10 +17 % / ±10 %	– +17 % / ±10 %	– –	– ±67 % / ±30 %	– ±67 % / ±30 %	– ±67 % / ±30 %
EB-PU2000 Series	Throw ratio Lens shift	WUXGA 16:10 – –	0.35:1 +25 % / ±15 %	0.35:1 +25 % / ±15 %	0.48 – 0.57:1 ±24 % / ±10 %	0.64 – 0.77:1 ±60 % / ±18 %	0.77 – 1.07:1 ±24 % / ±10 %
EB-PQ2000 Series	Throw ratio Lens shift	4K 16:9 – –	– +23 % / ±10 %	0.34:1 +23 % / ±10 %	0.34:1 ±18 % / ±6 %	0.46 – 0.56:1 ±18 % / ±6 %	0.62 – 0.75:1 ±58 % / ±16 %

Lens type	Wide throw	Wide throw	Mid throw	Mid throw	Mid throw	Mid throw	Long throw
Model name	ELPLW08	ELPLW06	ELPLM08*	ELPLM15	ELPLM10	ELPLM11	ELPLL08
Lens option							
Part code	V12H004W08	V12H004W06	V12H004M08	V12H004M0F	V12H004M0A	V12H004M0B	V12H004L08
Diagonal image size	50 – 1,000" (1.27 – 25.4 m)	50 – 1,000" (1.27 – 25.4 m)	50 – 1,000" (1.27 – 25.4 m)	50 – 1,000" (1.27 – 25.4 m)	50 – 1,000" (1.27 – 25.4 m)	50 – 1,000" (1.27 – 25.4 m)	50 – 1,000" (1.27 – 25.4 m)
EB-PU1000 Series	Throw ratio Lens shift	WUXGA 16:10 1.18 – 1.66:1 ±67 % / ±30 %	1.62 – 2.22:1 ±67 % / ±30 %	1.44 – 2.32:1 ±67 % / ±30 %	2.16 – 3.48:1 ±67 % / ±30 %	3.32 – 5.06:1 ±67 % / ±30 %	4.85 – 7.38:1 ±67 % / ±30 %
EB-PU2000 Series	Throw ratio Lens shift	WUXGA 16:10 0.86 – 1.21:1 ±60 % / ±18 %	1.19 – 1.62:1 ±60 % / ±18 %	– –	1.57 – 2.56:1 ±60 % / ±18 %	2.42 – 3.71:1 ±60 % / ±18 %	3.54 – 5.41:1 ±60 % / ±18 %
EB-PQ2000 Series	Throw ratio Lens shift	4K 16:9 0.83 – 1.17:1 ±58 % / ±16 %	1.15 – 1.57:1 ±58 % / ±16 %	– –	1.52 – 2.47:1 ±58 % / ±16 %	2.34 – 3.59:1 ±58 % / ±16 %	3.42 – 5.23:1 ±58 % / ±16 %

EB-PQ model specifications are preliminary and subject to change.

\* ELPLX01S/ELPLM08 lenses are only available for the EB-PU1000 models

\*\* ELPLX02S lenses are only available for the EB-PU2000/EB-PQ2000 models

\*\*\* ELPLW05 brightness is limited to maximum 12,000Lm





**EPSON  
WORLD LEADER  
IN PROJECTORS<sup>1</sup>**



1. 2001 to 2022, 500-lumen and above, excluding screenless TVs, Futuresource Consulting – Quarterly Projector Market Insights – Worldwide Analyzer CY22Q4.
2. Colour brightness (colour light output) in brightest mode, measured by a third-party lab in accordance with IDMS 15.4. Colour brightness will vary depending on usage conditions. Top-selling Epson 3LCD projectors versus top-selling 1-chip DLP projectors based on NPD sales data for January 2022 to December 2022.
3. As of December 2023. Main unit without lens. 10,000lm and 20,000lm in accordance with ISO 21118.
4. IP5X certified in accordance with IEC Standard 60529. The IP5X certification is applied to the optical engine and light source module.



Please recycle responsibly.

\* Warranty offers are not available for all countries. Please contact your local Epson representative.  
 For further information please contact your local Epson office or visit [www.epson.eu/contact-us](http://www.epson.eu/contact-us)  
 Austria 01 253 49 78 333 **Belgium** +32 (0)2 792 04 47 **Czech** +420 246 037 281 **Denmark** 44 50 85 85 **Finland** 09-3158 3267  
**France** 09 74 75 04 04 (Cost of local call, operator charges may apply) **Germany** +49 (0) 2159/92 79 500 **Greece** (0030) 211 198 62 12  
**Hungary** 06800 147 83 **Ireland** 01 436 7742 **Italy** 02-660321 10 (0,12 €/min) **Luxembourg** +352 27860692 **Netherlands** +31 (0)20 708 5099  
**Norway** +47 67 11 37 00 **Poland** +48 22 295 37 25 (0,16 zł/min) **Portugal** 707 222 111 **Romania** 0040 214025024 **Slovakia** +421 232 786 682  
**Spain** 935 821 500 **Sweden** +46 8 5051 3701 (Mobilsamtal – 0,99 kr/min, Lokala samtal – 0,30 kr/min, Utlandssamtal – 0,89 kr/min)  
**Switzerland** 022 592 7923 **United Kingdom** 0871 42 37766 (+10p per minute plus network extras)

Trademarks and registered trademarks are the property of Seiko Epson Corporation or their respective owners. Product information is subject to change without prior notice.

**EPSON®**